

# Hidden SIMS

Analytical Secondary Ion Mass  
Spectrometry Products

# Introduction to SIMS

## Sputter Erosion of the Specimen

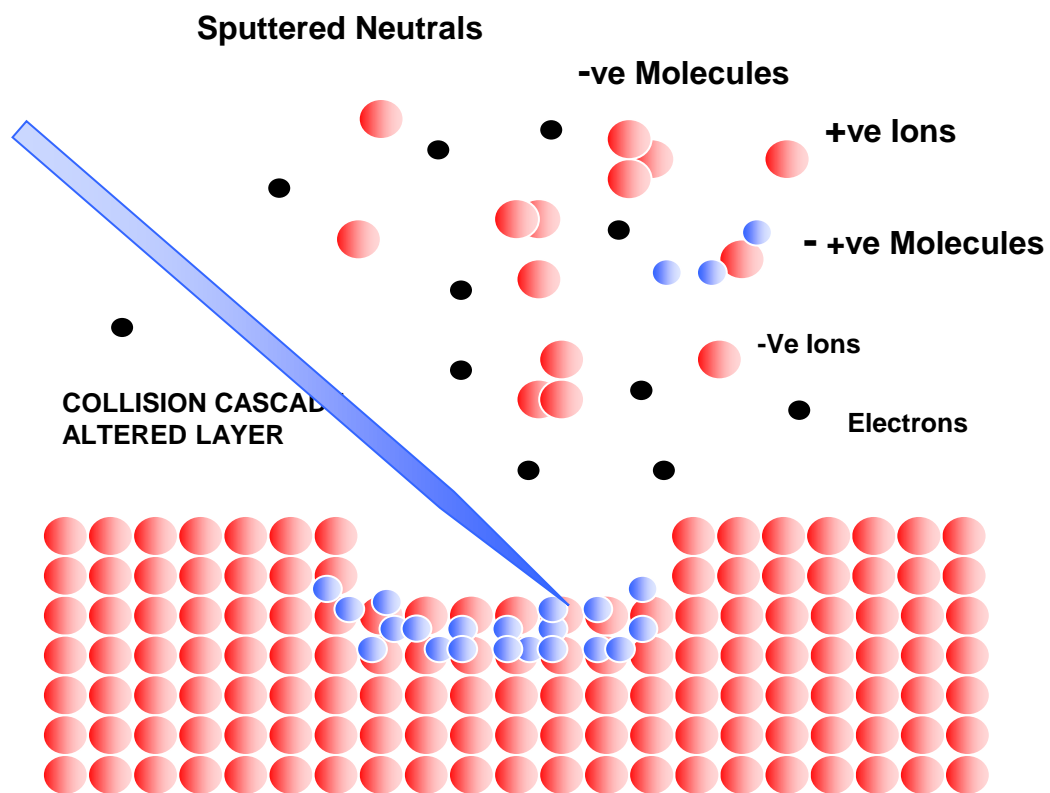

# Introduction to SIMS

## Sputter Erosion of the Specimen

### Static SIMS

- Very low ion dose ( $\sim 1 \text{E}12 \text{ ions cm}^{-2}$ ) gives surface specific measurement.
- Ideal for investigation of contamination, oxidation and monolayer coatings.

### Dynamic SIMS

- Higher ion dose erodes surface exposing deeper material.
- Monitoring mass resolved ion signals results in depth profile.
- Ideal for investigation of impurities (dopants) and layer structures

# Introduction to SIMS – sputter erosion of the specimen

Scanning the beam across the sample

- Flat bottom crater
- Imaging – collect data as a function of position
- Gating, only collect data when the beam is in the central flat part of the crater for high dynamic range depth profiles.

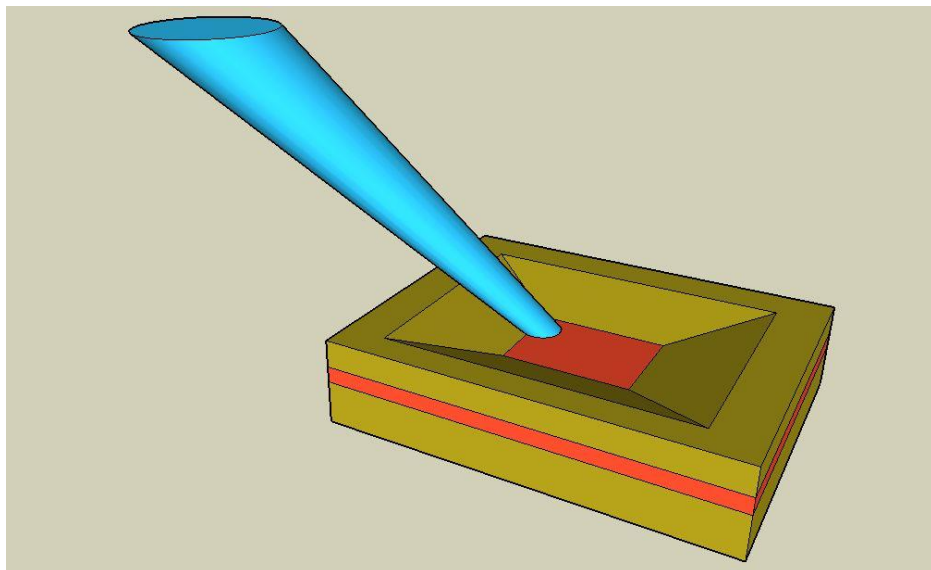

# Introduction to SIMS

## Anatomy of a Depth Profile

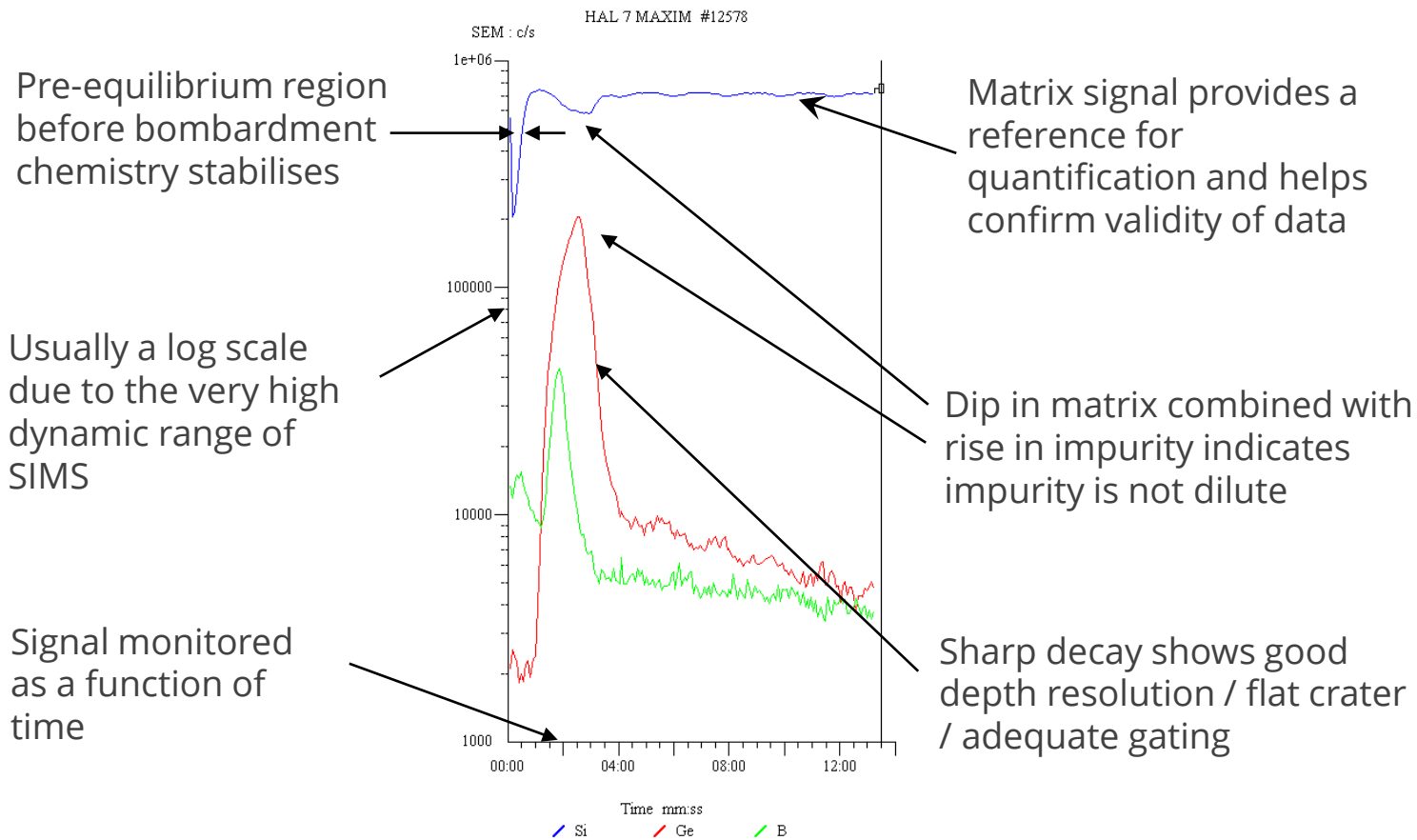

# Introduction to SIMS

## Primary ion beams

The probability of ion emission is affected greatly by the sample chemistry.

As the ion beam species becomes incorporated into the specimen it can be used to modify the surface chemistry and enhance probability of ionised emission.

- Oxygen enhances ionisation of electropositive elements
  - many metals and semiconductor matrix species
- Caesium enhances ionisation of electronegative elements
  - halogens, many contamination species, some metals
- Caesium can also be used to collect secondary ion cluster
  - (MCs<sup>+</sup>) of most species (M) at lower sensitivity but better linearity at high concentration.

# Introduction to SIMS

Relative Ion Yields - Positive SIMS Oxygen Primary Ions

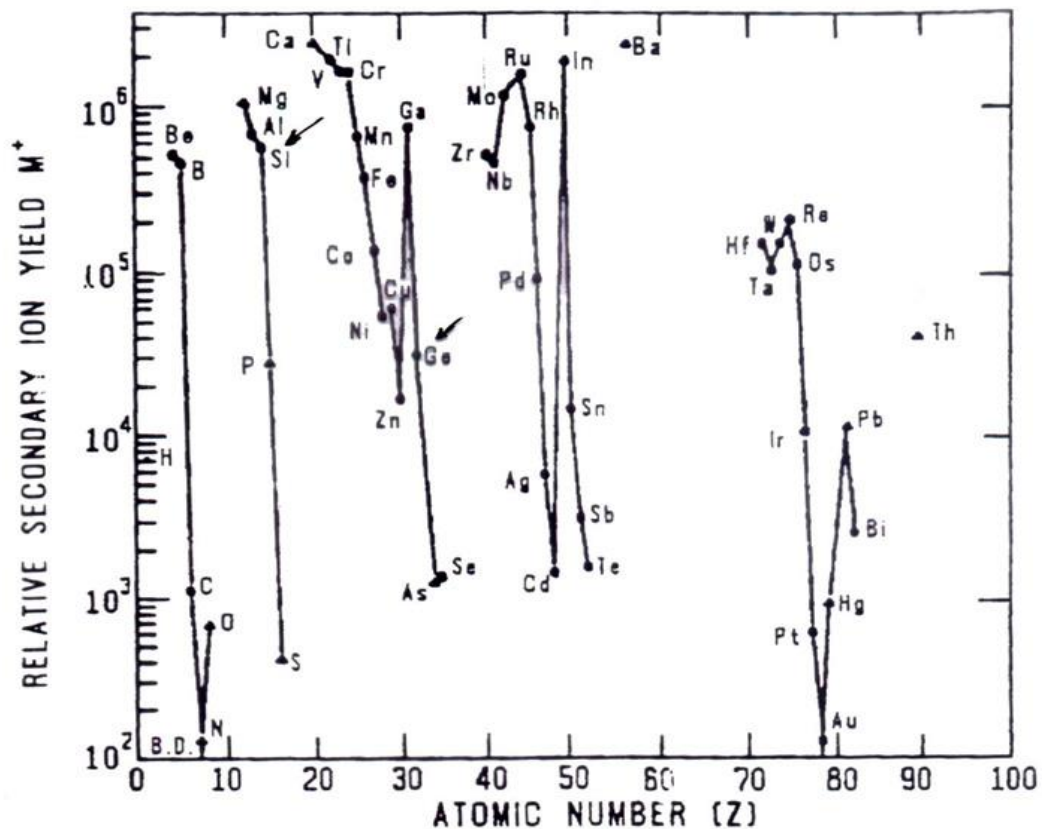

SIMS Handbook ed : Wilson R.G.; Stevie, F.A.; Magee, C.W.;  
John Wiley & Sons Inc. NY 1989

# Introduction to SIMS

Relative Ion Yields - Negative SIMS Caesium Primary Ions

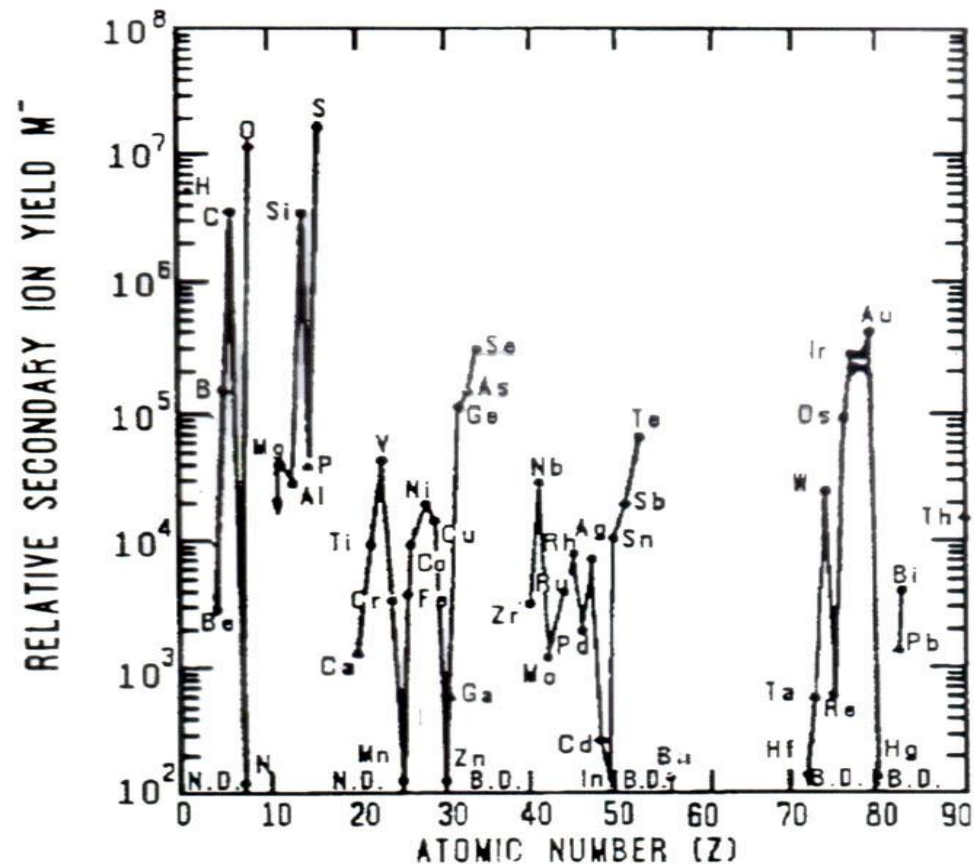

SIMS Handbook ed : Wilson R.G.; Stevie, F.A.; Magee, C.W.;  
John Wiley & Sons Inc. NY 1989



# Introduction to SIMS

## Recommended Primary Ions

Element	Ip	Ion	Notes
H	Cs	H-	2H if implant
He	O2	He+	No for HeCs+
Li	O2	Li+	
Be	O2	Be+	HMR in AlGaAs (Al3+)
B	O2	B+	BSi- also works
C	Cs	C-	CM- can give better DL
N	Cs	NM-	use N-15 if implanting
O	Cs	O-	use O-18 if implanting
F	Cs	F-	
Ne	O2	Ne+	or NeCs+
Na	O2	Na+	
Mg	O2	Mg+	
Al	O2	Al+	
Si	Cs	Si-	
P	Cs	P-	or P+ with O2 (HMR in Si)
S	Cs	S-	or S+ with O2 (HMR in Si)
Cl	Cs	Cl-	
Ar	O2	Ar+	or ArCs-
K	O2	K+	
Ca	O2	Ca+	
Sc	O2	Sc+	
Ti	O2	Ti+	or Ti- with Cs
V	O2	V+	or V- with Cs
Cr	O2	Cr+	
Mn	O2	Mn+	no Mn- ion
Fe	O2	Fe+	HMR in Si. Fe54 for implant
Co	O2	Co+	HMR in Si
Ni	O2	Ni+	or Ni- with Cs. HMR in Si
Cu	O2	Cu+	or Cu- with Cs.
Zn	O2	Zn+	or ZnCs+
Ga	O2	Ga+	
Ge	Cs	Ge-	or 70Ge+ with O2
As	Cs	AsM-	or 75As- HMR in Si
Se	Cs	Se-	
Br	Cs	Br-	

Element	Ip	Ion	Notes
Kr	O2	Kr+	or KrCs+ with Cs
Rb	O2	Rb+	
Sr	O2	Sr+	
Y	O2	Y+	
Zr	O2	Zr+	
Nb	O2	Nb+	
Mo	O2	Mo+	
Ru	O2	Ru+	or Ru- with Cs
Rh	O2	Rh+	or Rh- with Cs
Pd	O2	Pd+	or Pd- with Cs
Ag	O2	Ag+	or Ag- with Cs
Cd	O2	Cd+	or CdCs+. No Cd- ion
In	O2	In+	
Sn	O2	Sn+	or Sn- with Cs
Sb	Cs	Sb-	or SbM- or Sb+ with O2.
Te	Cs	Te-	
I	Cs	I-	
Xe	O2	Xe+	no XeCs+
Cs	O2	Cs+	
Ba	O2	Ba+	HMR in GaAs
La	O2	La+	all La rare earths as La
Hf	O2	Hf+	no Hf- ion
Ta	O2	Ta+	
W	O2	W+	
Re	O2	Re+	
Os	Cs	Os-	or Os+ with O2
Ir	Cs	Ir-	
Pt	Cs	Pt-	
Au	Cs	Au-	
Hg	O2	Hg+	or HgCs+. no Hg- ion
Tl	O2	Tl+	
Pb	O2	Pb+	HMR in GaAs
Bi	Cs	Bi-	or BiM- or Bi+ with O2
Th	O2	Th+	
U	O2	U+	

# Hidden SIMS Products

- Ion Guns
  - Inert gas
  - Reactive gas
  - Caesium
- Spectrometers
  - Basic
  - Energy analysing (surface science)
  - High transmission (surface analysis)
- Complete systems
  - SIMS Workstation family
  - SIMS on a flange
  - Compact SIMS
- Customisation
  - Addition of other techniques and special configurations

# Hidden SIMS Products – Ion Guns

## IG20 Gas Ion Gun

- 1-5 keV, 0.5  $\mu$ A, 100 $\mu$ m (50 $\mu$ m imaging)
- Reliable, long life, electron impact ion source
- Integral bend to remove neutral particles
- May be used with reactive and inert gases (e.g. H, He, O, N, Ar, Xe, air)
- Differential pumping to preserve chamber UHV
- Bakeable to 250°C
- Mounts on CF35



# Hidden SIMS Products – Ion Guns

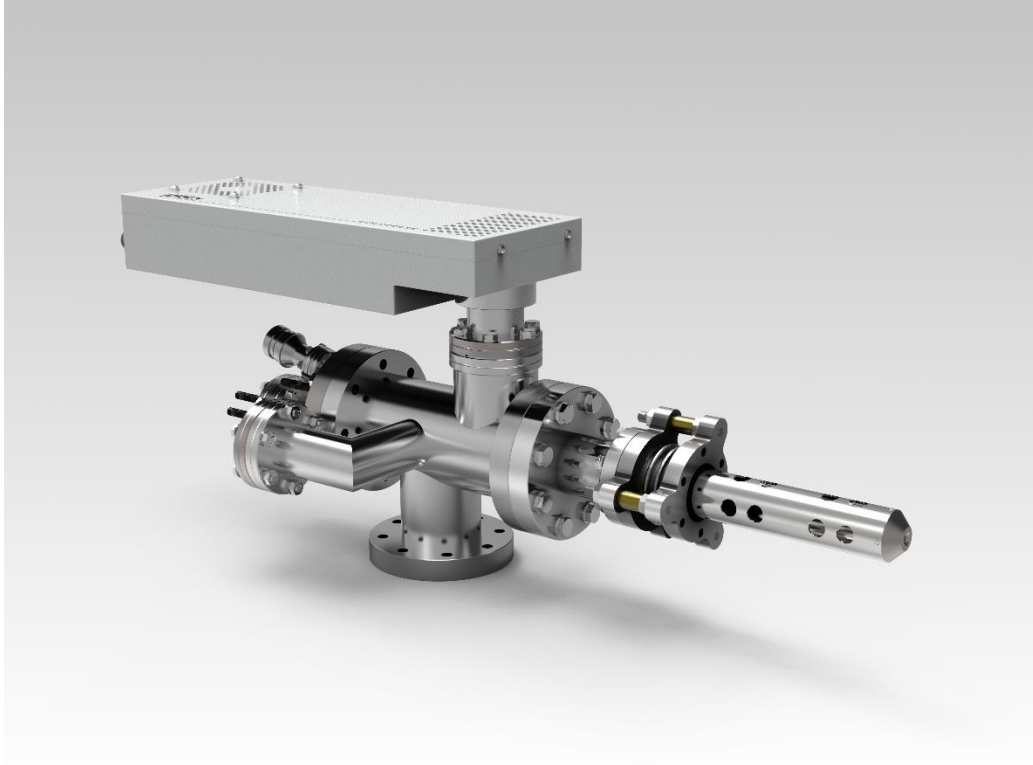

## IG5C Caesium Ion Gun

- 1-5 keV, 150nA, 80 $\mu$ m (20 $\mu$ m imaging)
- Miniature low power Cs Ion source (~8W), long life, easy replacement.
- Air stable
- Double bend to remove neutral particles
- Differential pumping to preserve chamber UHV
- Bakeable to 250°C
- Mounts on CF35

# Hidden SIMS Products – Ion Guns

## Ion Gun Control

PC controlled

Settings can be saved and recalled

Automatic ion source warm up / cool down

EHT ramp rate control

Gun diagnostics

Connect via TCP/IP, USB or serial

Upgradeable software and firmware

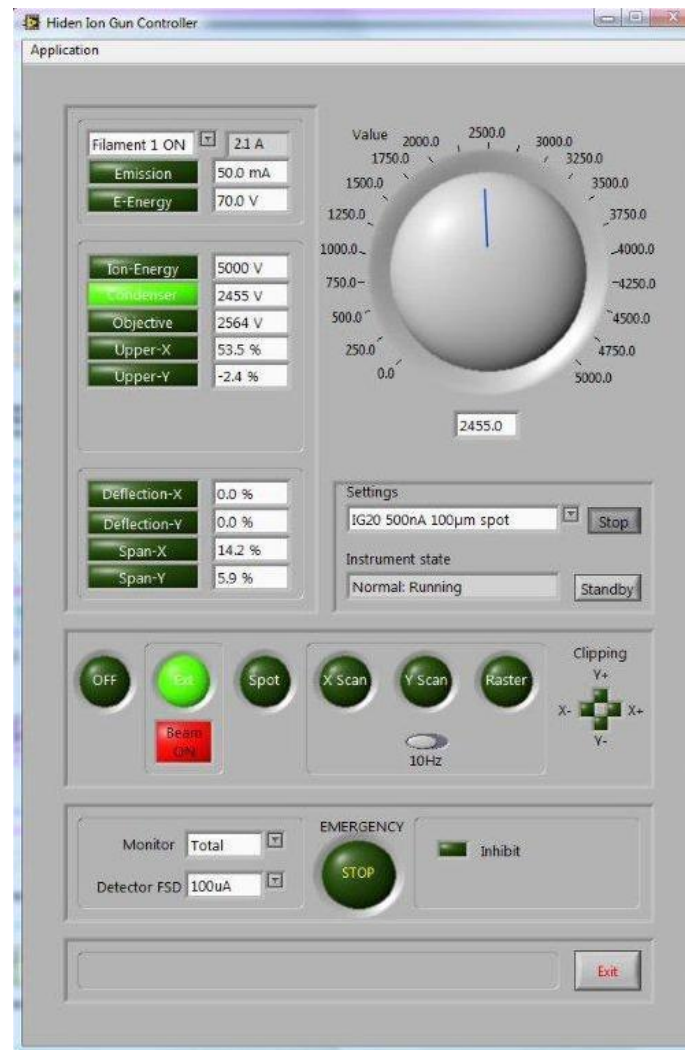

# Hidden SIMS Products – Spectrometers

## Secondary Ion Mass Spectrometers

- SIM – Basic on-axis probe, positive ion only
- EQS – 45° electrostatic sector for mass and energy measurement, excellent energy filtering, on-axis collection
- MAXIM – 30° off axis collection, maximum sensitivity, integrated SNMS

# Hidden SIMS Products – Spectrometers

MAXIM – High Performance SIMS and SNMS

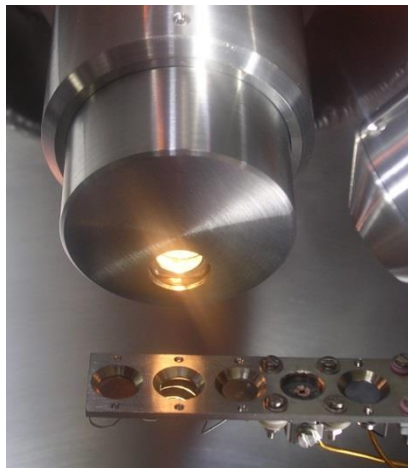

Easy to change filament for SNMS

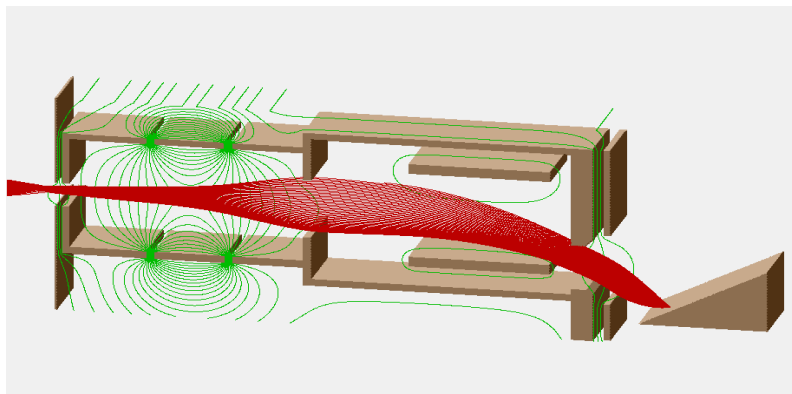

Off-axis collection



# Hidden SIMS Products – Spectrometers

EQS – On-axis sampling, energy resolving mass spectrometer

Easily fits to other surface analysis and FIB tools



- Zeiss Nvision X-beam FIB with EQS



# Modular SIMS

**Complete SIMS on a single flange (IG20 + EQS + spare ports)**

- Positive and negative ions
- Oxygen and Inert gas ion gun (Cs option)
- Sample viewing
- Aligned port for charge compensation electron gun
- Large range of working distance and off axis analysis position can be specified

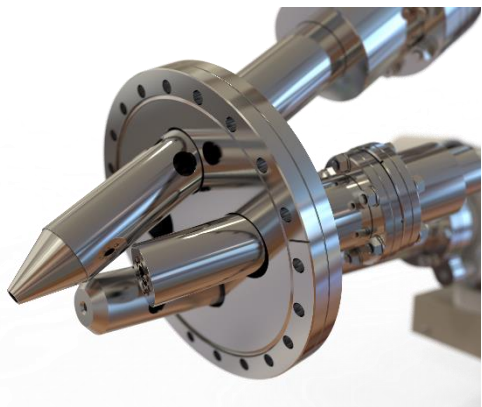

Mounted on a surface analysis chamber

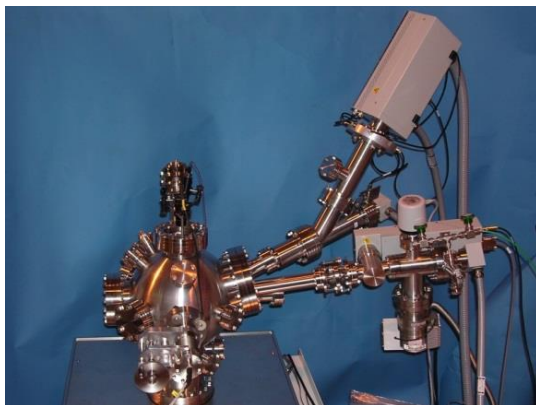

Mounted on an MBE system preparation chamber

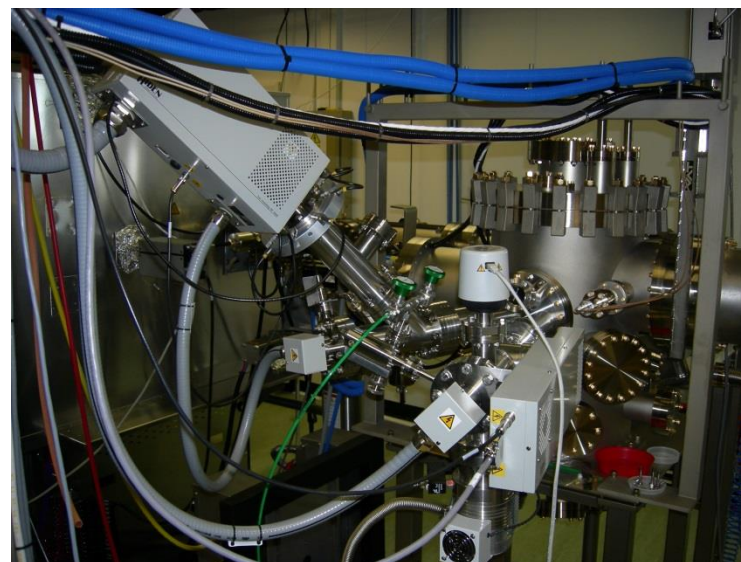

# Hidden SIMS Workstation

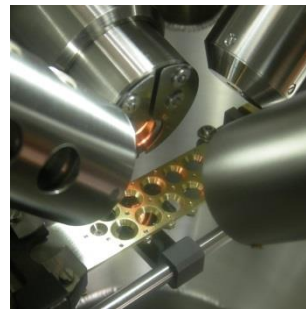

- 3D imaging
- Depth profiling
- Static SIMS
- SNMS
  
- MAXIM SIMS/SNMS
- Oxygen Ion Gun
- Cs Ion Gun
- Electron charge compensation gun
- O<sub>2</sub> gas jet
- Loadlock degas heater
- Large area near sample cryotrap
- UHV – bakeable
- Large sample holder
- Normal incidence camera
  
- Single phase 2500 W
- No compressed air
- Air cooled
- Remote backing pump option
- All dry pumps

# Hidden SIMS Workstation - sample mounting

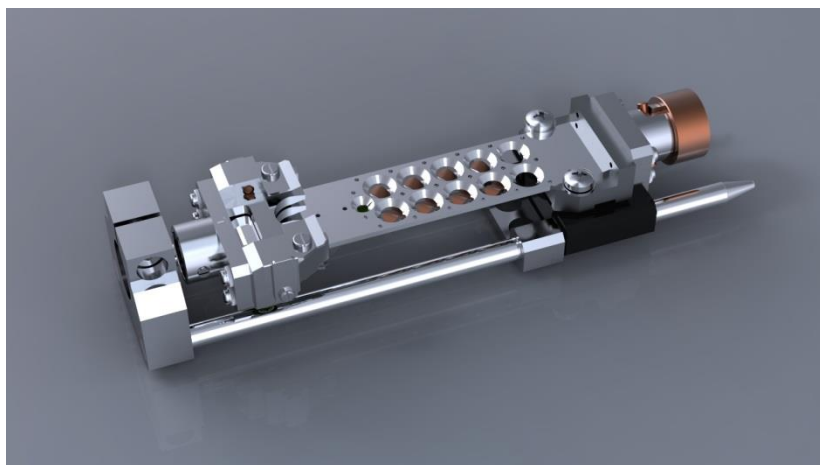
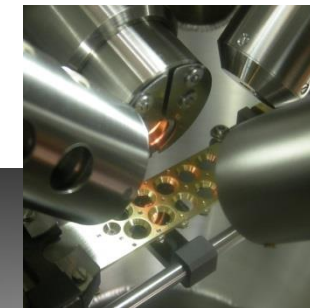
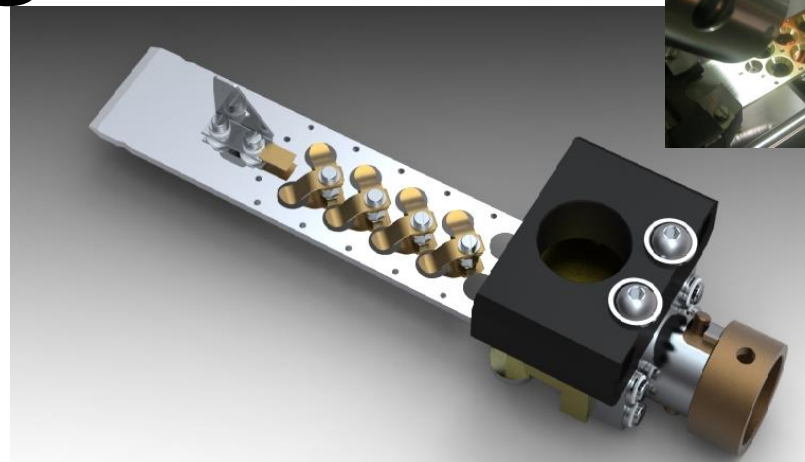
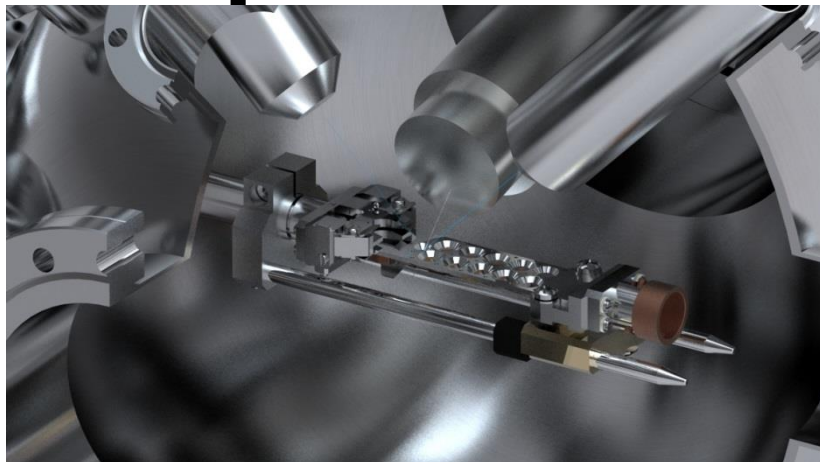

- Samples mount from the underside .
- The upper surface is always in the correct plane for analysis.
- Maximum sample thickness 10mm
- Maximum size to load 40 x 40mm
- Easily customisable sample bar
- Spring clip and screws – no adhesive
- Sample bar carries Faraday cup for beam set-up
- Positive bayonet connection and guidance forks make transfer robust and reliable.



# Hidden SIMS Workstation - loadlock sample heater

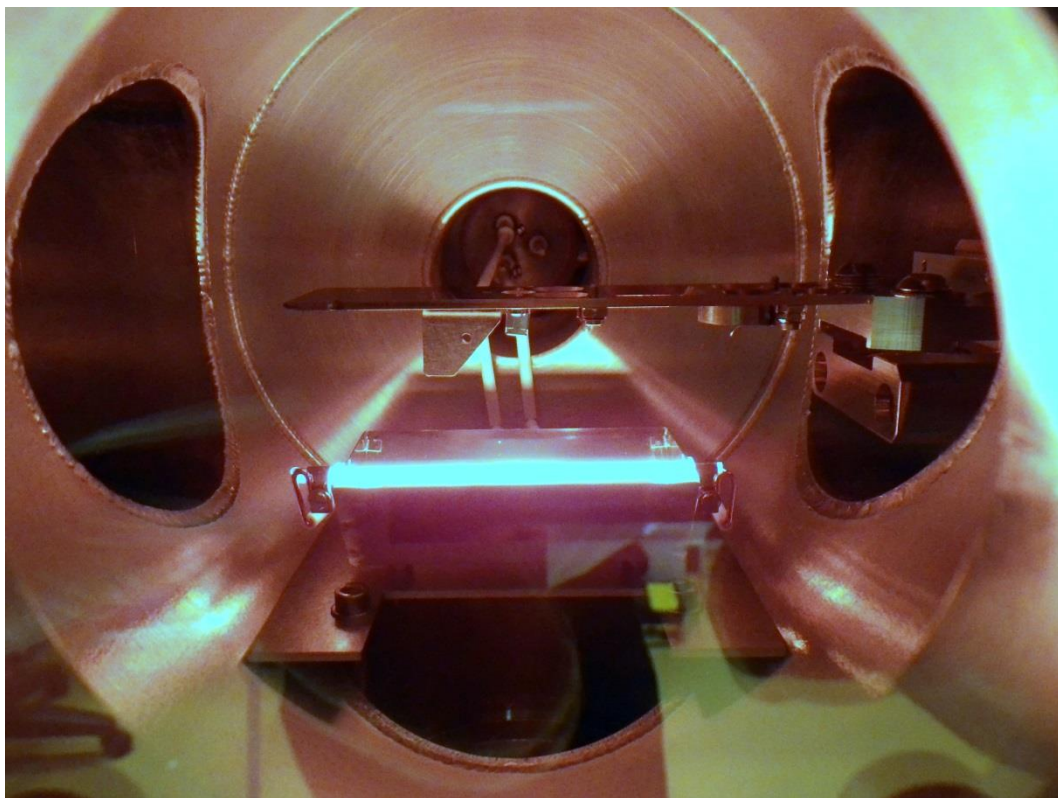

## Infra-red sample heating in loadlock

- High purity heater
- Heating from underside (clean top surface)
- Non-contact infra-red
- Uniform heating
  
- Degas of adsorbed water vapour and volatile compounds.
- Reduced background of hydrogen, oxygen and carbon.
- Preserves UHV environment.

## SIMS Workstation with XPS

The SIMS workstation is designed to be customisable and has spare ports for the fitting of other techniques or devices.

Here the instrument is configured for SIMS, SNMS and XPS with the addition of the SPECS PHOIBOS 150 analyser and dual anode x-ray source.

A rotation drive allows the sample to be positioned at the optimum angle for XPS or to make angularly resolved measurements.

## SIMS Workstation family

The Hiden SIMS Workstation is a modular instrument. All members of the family are based around the same components so it is easily upgradeable from the basic *Foundation* to the fully configured *Plus* version.

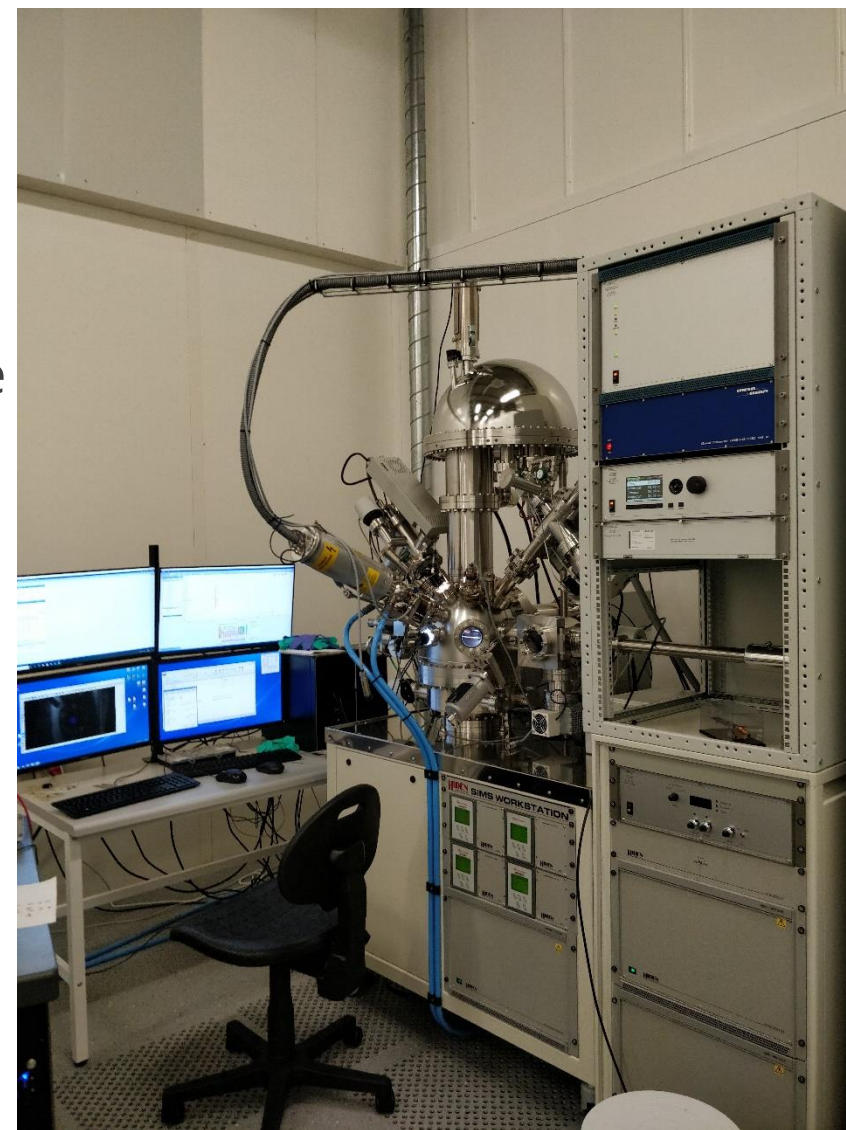

# Compact SIMS - Overview

The Hiden Compact SIMS tool is designed for fast and easy characterisation of layer structures, surface contamination and impurities with sensitive detection of positive ions being assisted by the oxygen primary ion beam and provides isotopic sensitivity across the entire periodic table.

The ion gun geometry is set to provide for ideal nanometre depth resolution and near surface analysis.

## Features

- Small footprint
- Easy “user friendly” layout
- Requires only single phase electrical power (under 10A 220Vac)
- Wheeled trolley design
- Positive SIMS and SNMS
- Depth Profiling
- 3D characterisation and imaging
- Mass spectra
- Isotopic analysis

## Applications

- Thin films
- Surface coatings
- Semiconductors
- Catalysis
- Magnetic media
- Pharmaceuticals
- Corrosion studies
- Nanotechnology

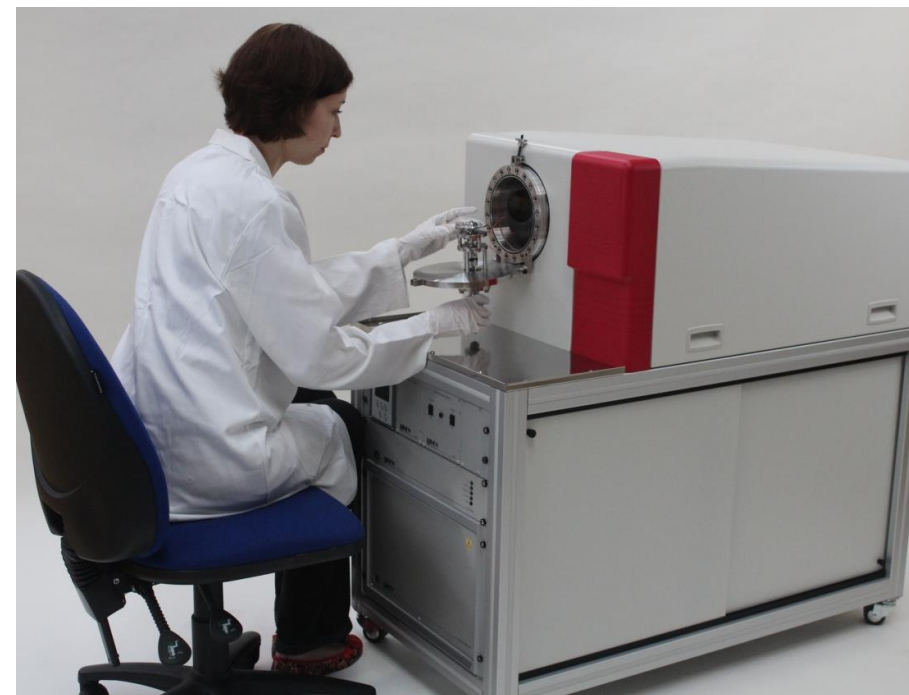



# Sample loading

MAXIM-600P SIMS detector

IG20 gas ion gun

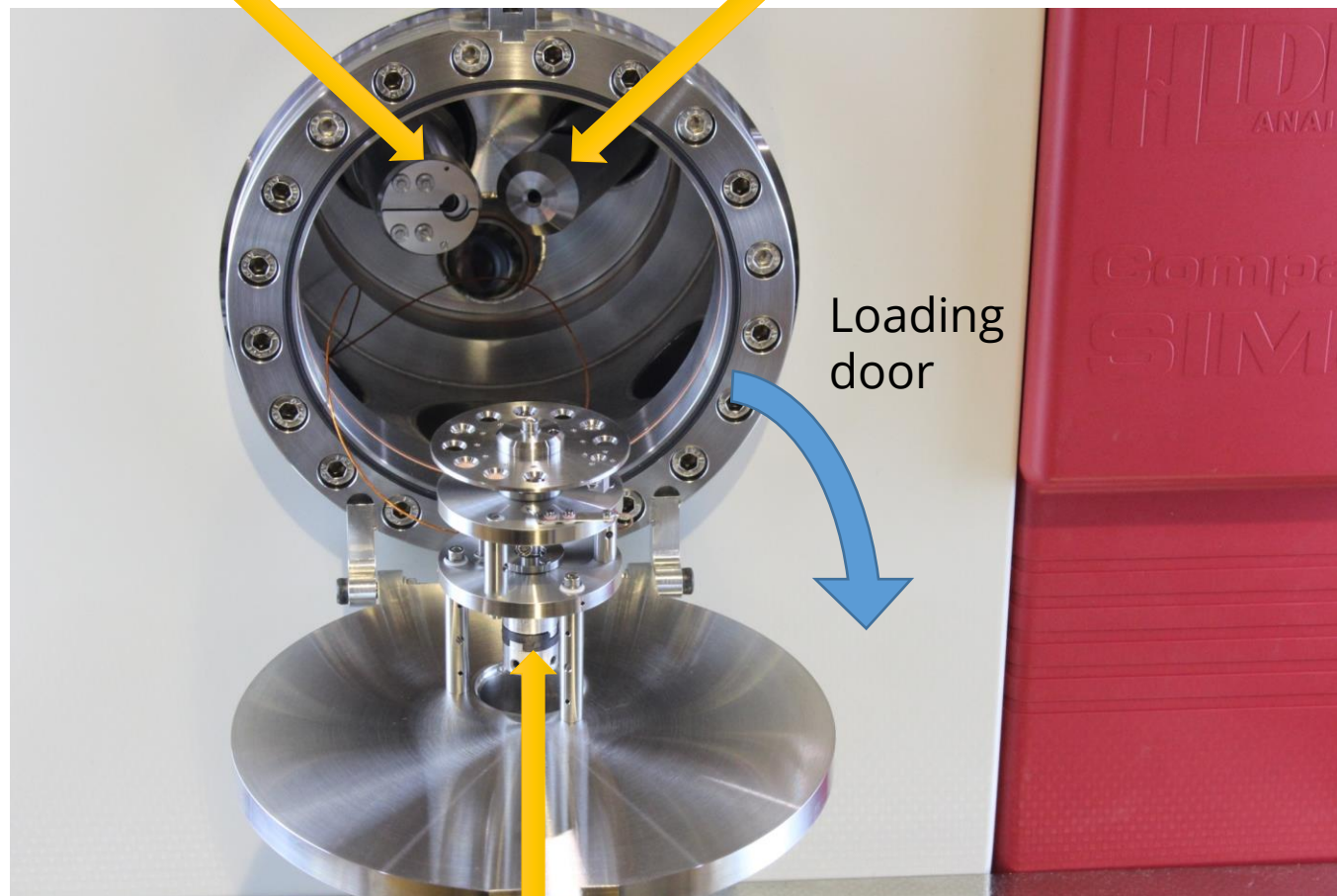

Loading door

Rotary carousel

# Applications – depth profiling GaAs quantum well structure

Negative secondary ions with 5keV Cs primary ion bombardment

n-GaAs:Si >  $10^{19}$  ~ 0,1  $\mu\text{m}$

n-AlGaAs:Si >  $10^{18}$  ~ 0,1  $\mu\text{m}$

p-AlGaAs:C >  $5 \times 10^{19}$  ~ 0,1  $\mu\text{m}$

GaAs undoped ~ 0,1  $\mu\text{m}$

InGaAs QW undoped ~ 6 nm

GaAs undoped ~ 0, 2  $\mu\text{m}$  (buffer layer)

n-GaAs - substrate

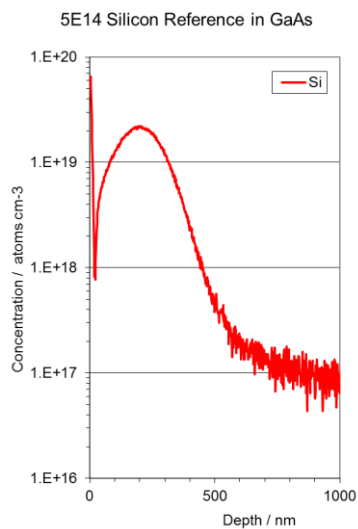

Typical Si detection limit in GaAs  $1E17$  atoms  $\text{cm}^{-3}$

Negative SIMS Depth Profile - Raw data

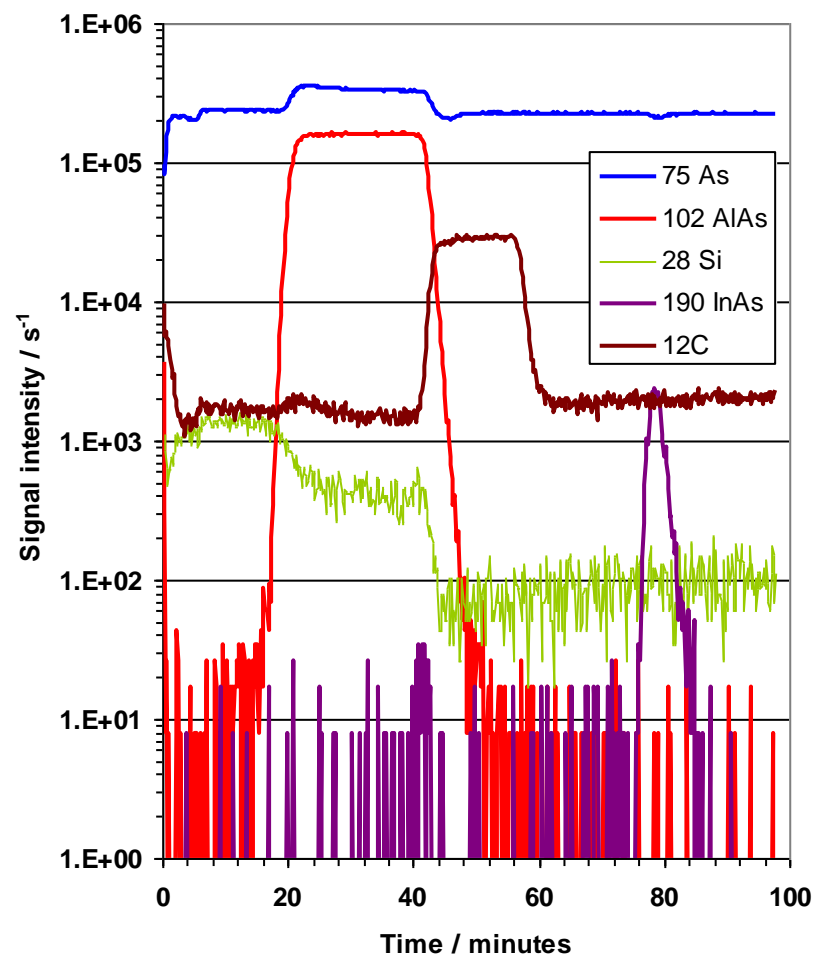



# Applications – depth profiling – Ion Implanted reference materials

1E15 Mg implant into Si

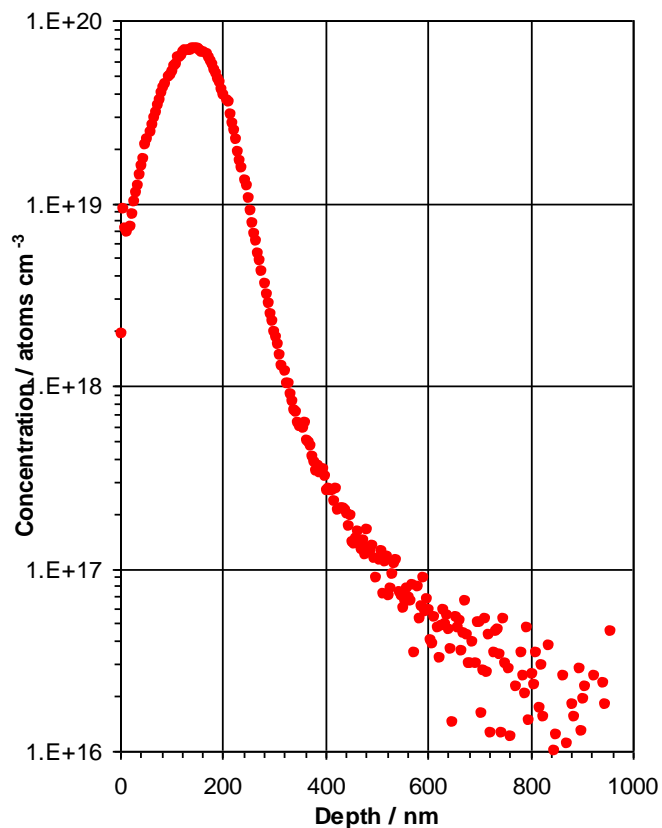

**<sup>24</sup>Mg implant in Si**,  $10^{15}$  atoms  $\text{cm}^{-2}$  analysed using **oxygen primary ions** from IG20 ion gun on SIMS Workstation with MAXIM spectrometer.

5E15 As implant into Si

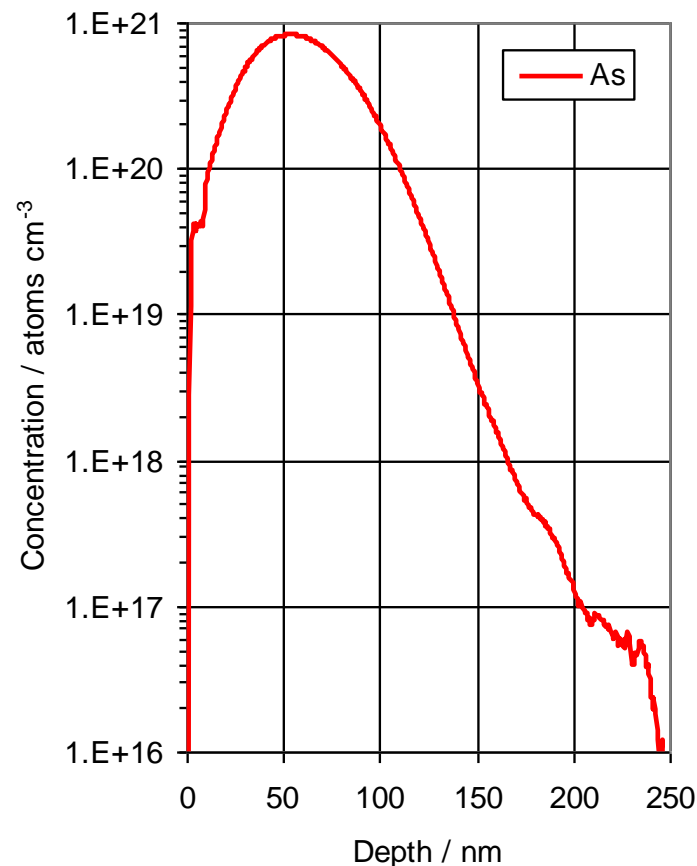

**As implant in Si**,  $5 \times 10^{15}$  atoms  $\text{cm}^{-2}$  analysed using 5keV **Cs<sup>+</sup> primary ions** from IG5C ion gun on SIMS Workstation with MAXIM spectrometer.

# Depth Profiling – detection limits

Detection limit depends on:

- Ion yield
- Volume of analyte; large volume = better statistics, lower DL, but bigger crater or depth increment
- Background or interfering signals – use energy offset to reduce molecular interference, ensure clean surfaces and good ion beam shape, UHV and cold trap to reduce effect of residual gas species (H, O).
- Use 3D data collection to optimise gating

Element	Matrix	Detection limit	Comment
		At/cc	
<b>28 Si</b>	GaAs	8E16	Interference signals from AlH in GaAlAs – 5E17 with background subtraction when possible
<b>11 B</b>	Si	2E16	Surface boron contamination gives rise to background, ultimate shown in clean silicon sample.
<b>31 P</b>	Si	7E17	Interference from SiH at mass 31- energy offset and loadlock degas for best result
<b>2 D</b>	Si	1E18	Subtract contribution from natural H for ultimate DL – use cold trap
<b>2 D</b>	W	2E18	Subtract contribution from natural H for ultimate DL – use cold trap
<b>24 Mg</b>	Si	5E16	
<b>75 As</b>	Si	8E16	
<b>9 Be</b>	Si	2E17	

# Applications - depth profiling

## Depth Profiling Neutron Mirror - 80x 3.6nm Period

A Si/Fe, 80-period, neutron mirror was analysed using normally incident 1.5keV  $O_2^+$  primary ions (100nA) from the IG20 gas gun and detecting secondary ions with the MAXIM SIMS analyser. Although the layers are not fully resolved, the profile shows the thickness to be highly consistent with no loss of depth resolution with depth.

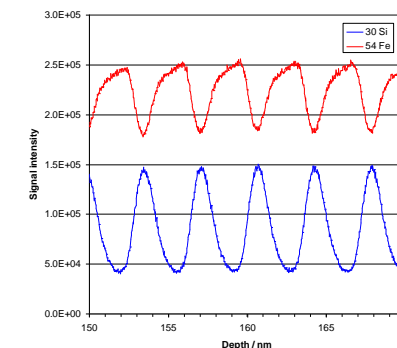
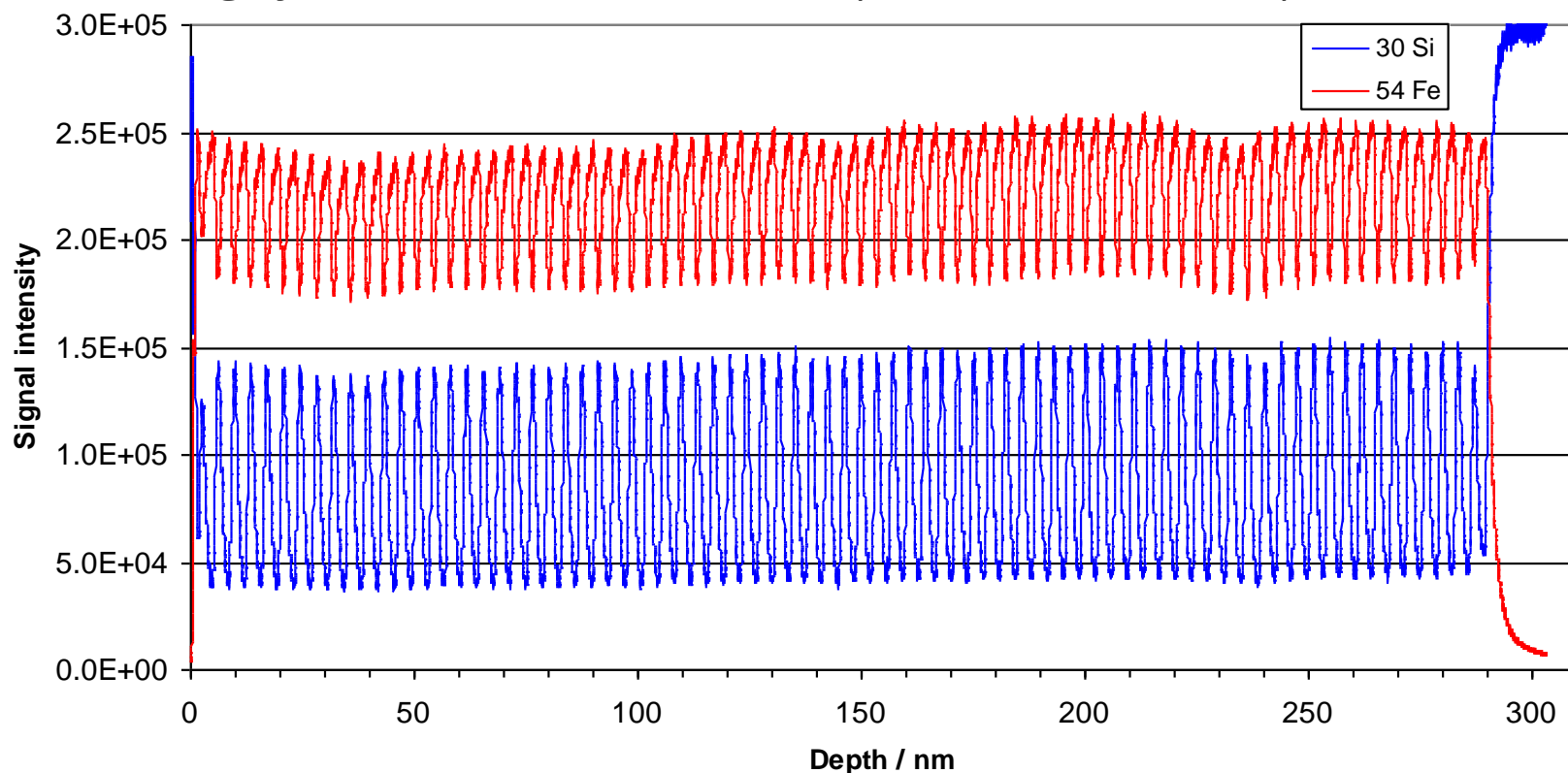

# SNMS (sputtered neutral Mass Spectrometry) – Post Ionisation

The generation of ions during sputtering depends very strongly on the chemistry of the sample and primary ion beam and the ion yield can vary non-linearly over orders of magnitude. This 'matrix effect' makes quantification of SIMS data difficult when impurities reach high concentration (> 2%) or when the matrix varies. Sputtered Neutral Mass Spectrometry overcomes this problem and permits quantification in this extremely useful range by separating the ionisation from the sputtering.

- Electron impact cell ionises the sputtered neutral material
- Secondary ions deflected from analyser
- Separating the sputter and ionisation events removes most of the SIMS matrix effect
- Easily quantifies large changes in matrix material
- Detection limit typically <0.1 atomic%
- Excellent for alloy multilayers
- No requirement for matrix matched reference materials
- Neutral species are unaffected by surface charging

# SNMS on the MAXIM

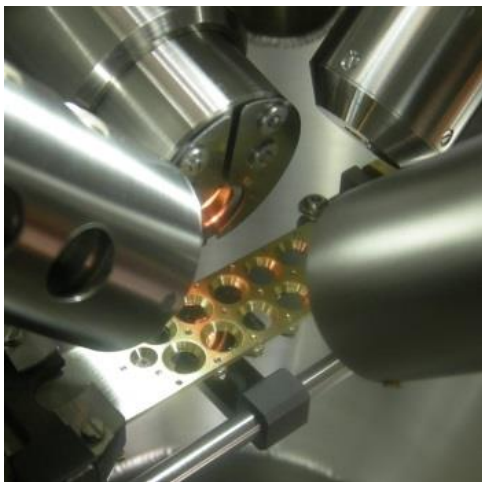

The MAXIM SIMS/SNMS spectrometer has an electron impact ion source fitted close to its entrance. An external deflector plate removes the secondary ions (which generally constitute less than 1% of the sputtered flux) and allows the neutrals to enter the ioniser. Once ionised, the neutrals follow the same path that SIMS ions would have taken.

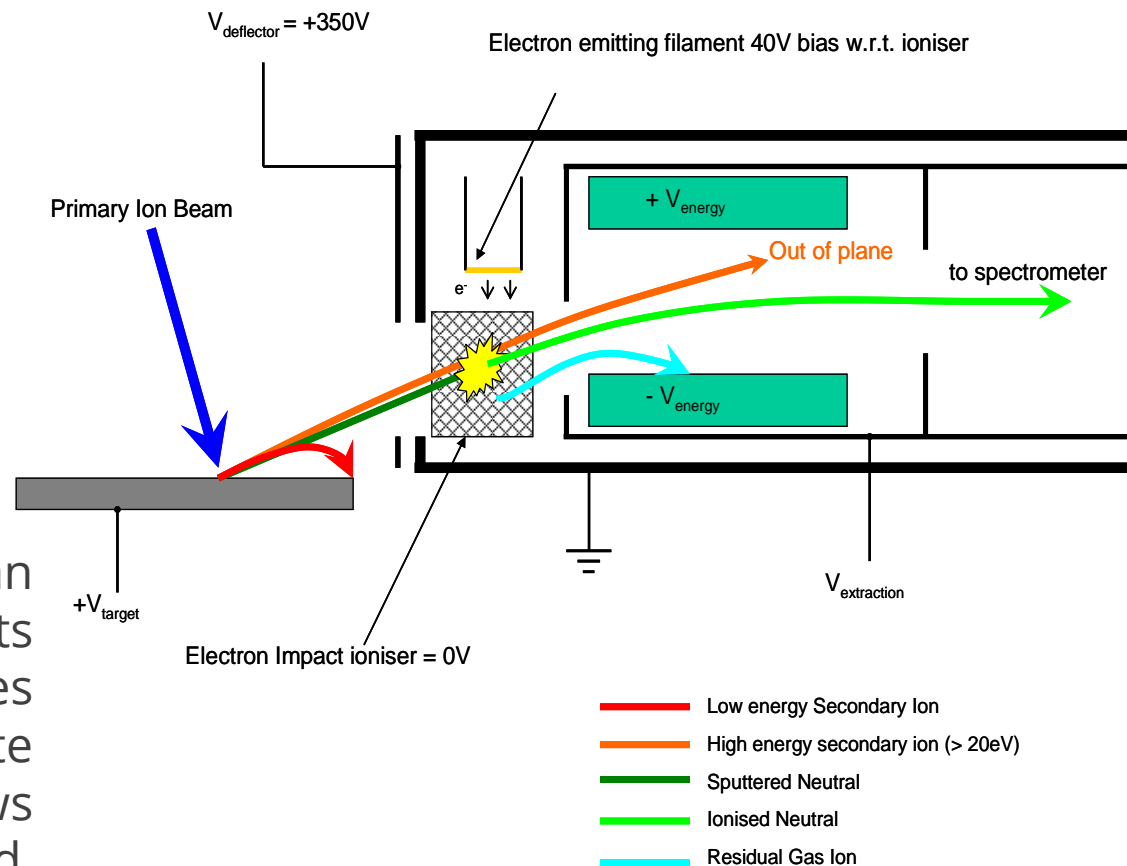

# SNMS with appearance energy discrimination

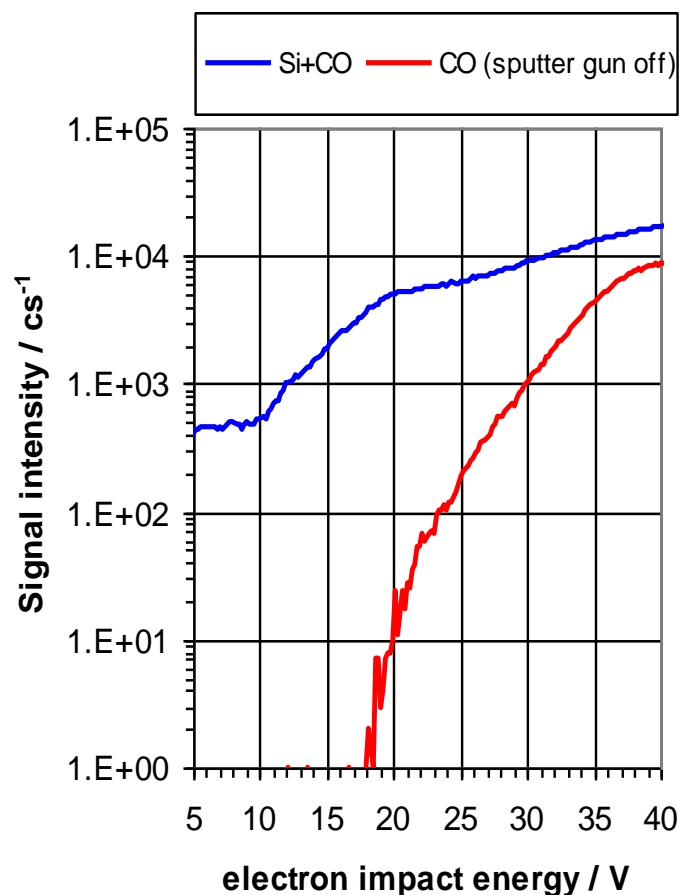

The ability to control the electron impact energy enables some mass interferences to be easily overcome using the ion appearance energy.

For example, CO (mass 28) is a common residual gas constituent and could interfere with the detection of the major isotope of silicon. However, careful choice of the electron energy resolves this problem.

Reducing the electron energy to below 19V prevents ionisation of residual CO, confirmed here by noting the lack of signal with the sputter gun off (red) so with the gun on (blue) the detected signal is from silicon only.

# SNMS - Magnetic Storage Materials

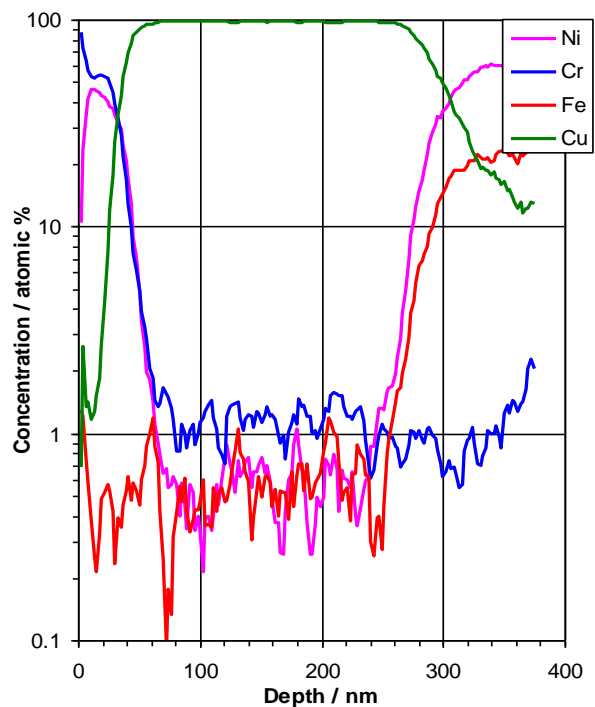

SNMS depth profile of NiCr/Cu/NiFe disk head layer structure, primary ions 5 keV Ar from IG20 ion gun

SNMS Depth Profile of Hard Disk Platter

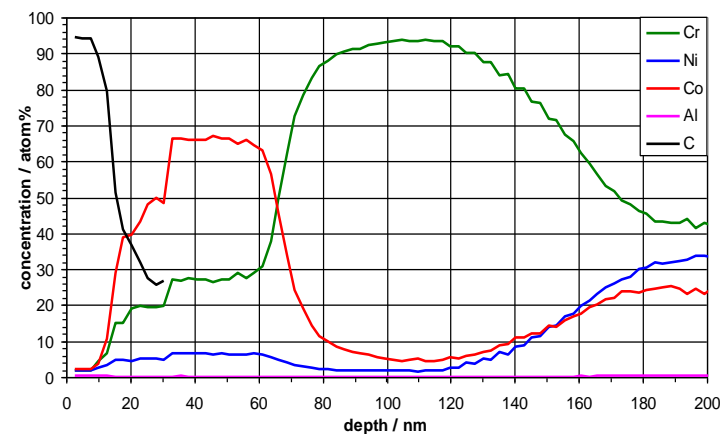
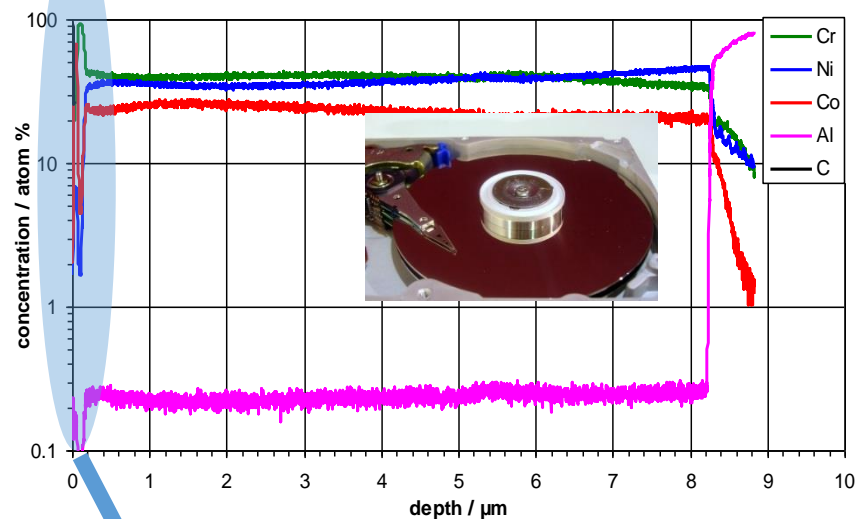



# Control of surface topography during sputtering – Oxygen jet

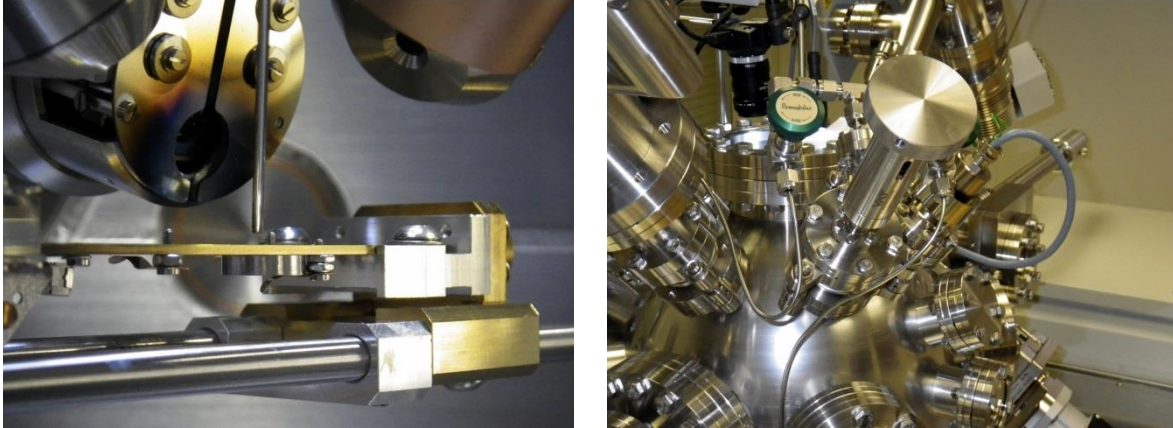

Low energy beams give improved depth resolution but can also induce surface topography.

Fully oxidising the surface using the jet maintains a planar surface and preserves depth resolution.

The jet provides a locally high pressure of pure oxygen over the sample.

2keV 100nA ion beams at 45°. Target 3.6nm Si/Fe multilayer

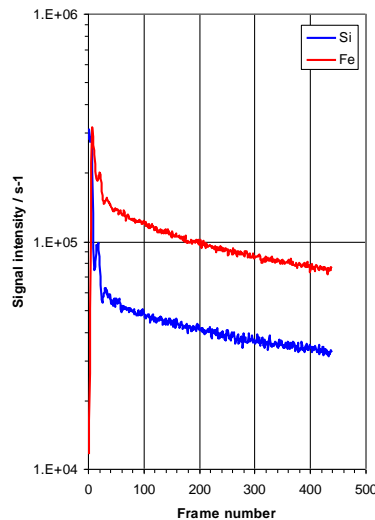

Ar no jet

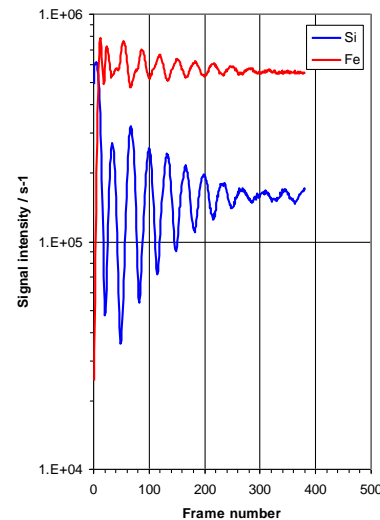

Ar with jet

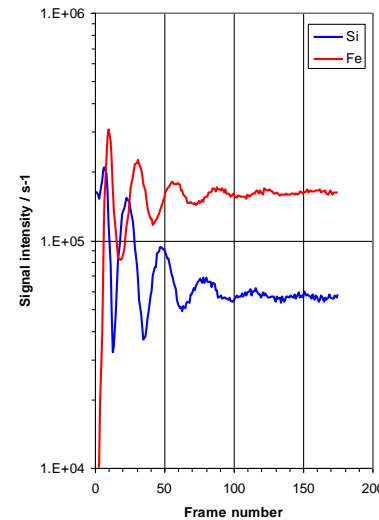

O<sub>2</sub> no jet

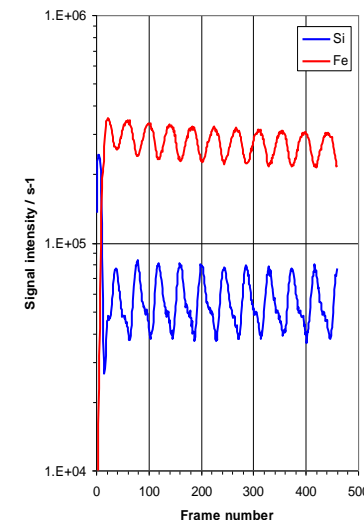

O<sub>2</sub> with jet



# Static SIMS – Contamination on Diesel Injector



After a period of intense engine running, a hard, stain like, deposit was observed on a fuel injector component.

EDX (energy dispersive X-ray) analysis in the SEM was inconclusive as the thin nature of the deposit meant that most of the excited volume was in the underlying metal.

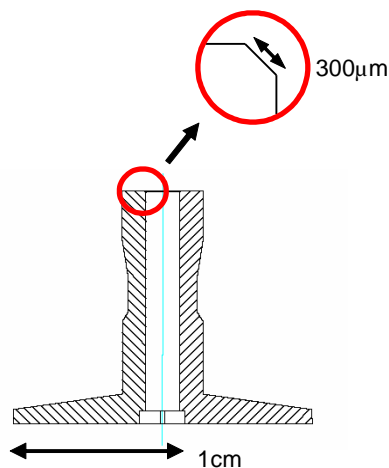

# Static SIMS – Contamination on Diesel Injector

$^{56}\text{Fe}$  SIMS images of the defective region. The right hand image shows detail in the position of the arrow, where something is blocking the iron signal from the steel. The very bright region is caused by ions being directed into the spectrometer by the angled face.

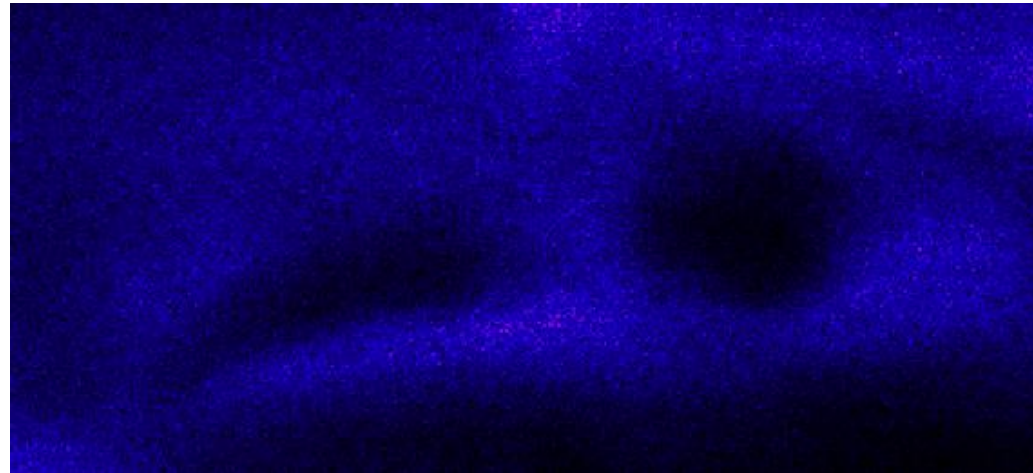
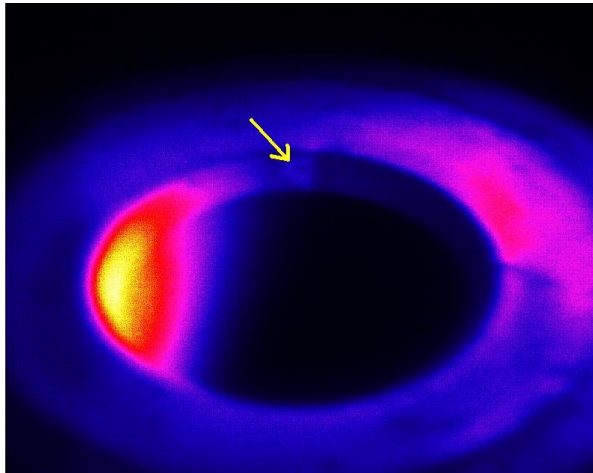

# Static SIMS – Contamination on Diesel Injector

Positive SIMS Mass Spectrum of Cleaned Surface

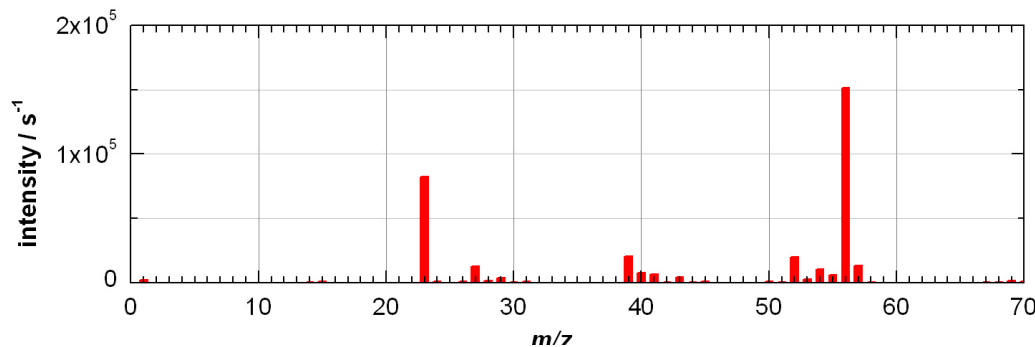

A localised mass spectrum from the steel shows typical constituents,

- Fe at 54-58, with the major isotope at 56
- Cr at 50-54 with the major isotope at 52
- and Na (23) and K(39 and 41) being contaminants to which SIMS is extremely sensitive.

Positive SIMS Mass Spectrum of Contamination

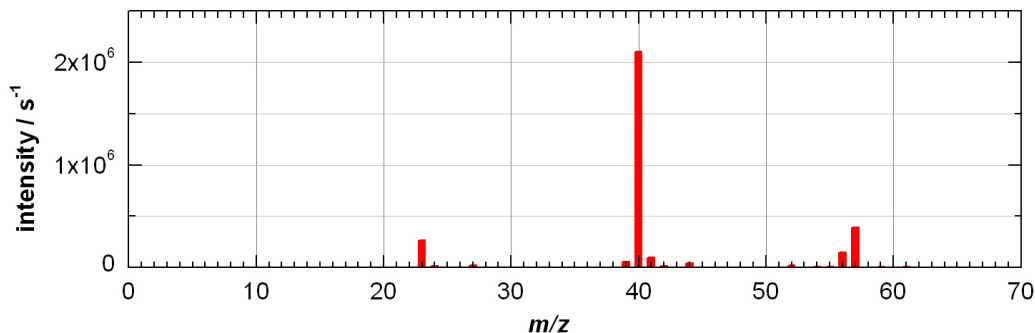

The localised mass spectrum from the defect is dominated by Ca.

The defect is Ca based and it is suggested that this is due to a bio-diesel catalytic production step. This known possible fuel contaminant is limited by EU regulations to 5mg/kg (summed with the Mg content).

# Focused Ion Beam - SIMS

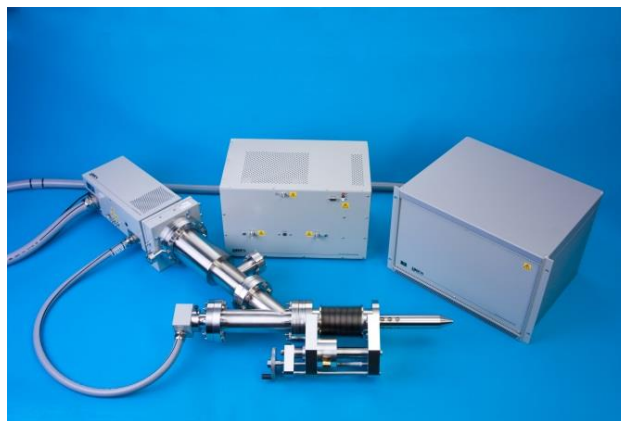
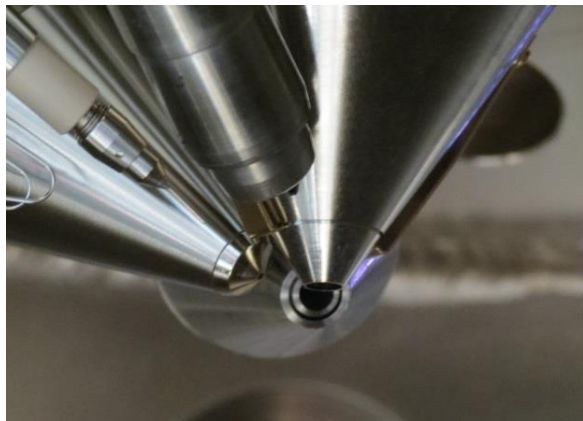

High sensitivity EQS

- Shielded low voltage extraction
- 50mm Z-Drive
- Depth profiling
- 3D and 2D Imaging
- Option for differential pumping
- Customisable length and fitting adaptors

Zeiss Nvision X-beam FIB with EQS



# Focused Ion Beam - SIMS

2  $\mu$ m

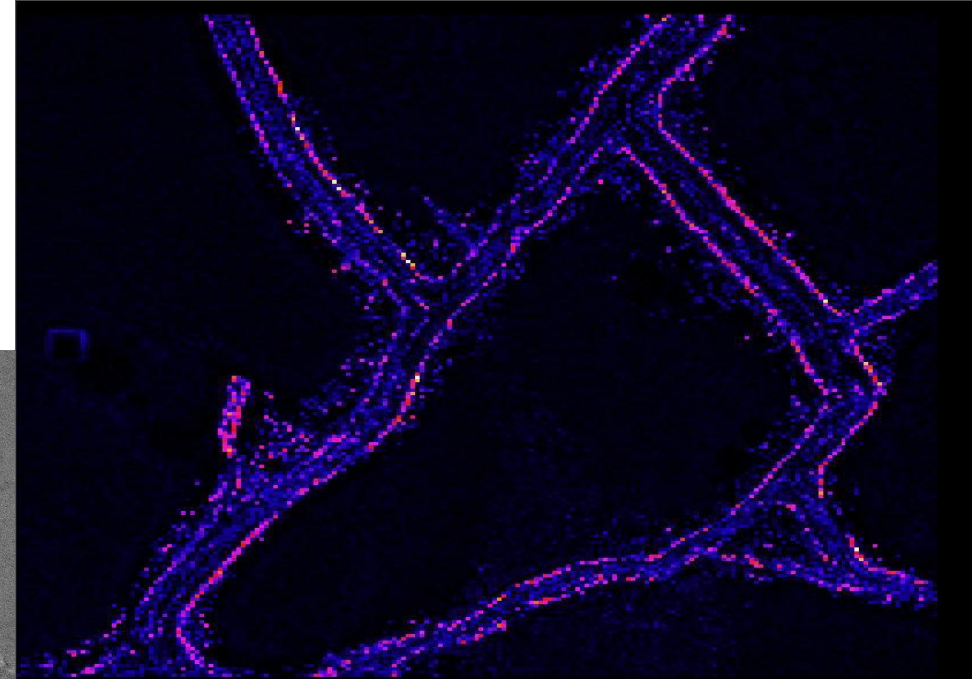
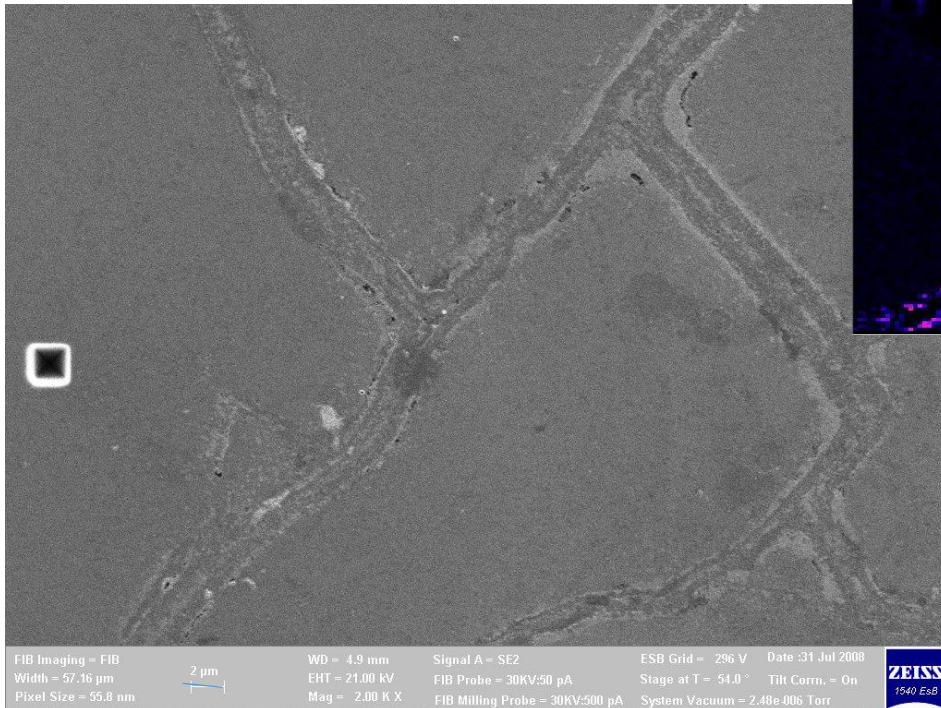

$^{27}\text{Al}$  image showing concentration at grain boundary of LaSrCuFe oxide.

Sample: Richard Chater, Imperial College

Instrument: Zeiss Neon Hiden EQS

FIB Imaging = FIB  
Width = 57.16  $\mu$ m  
Pixel Size = 55.8 nm

WD = 4.9 mm  
EHT = 21.00 kV  
Mag = 2.00 K X

Signal A = SE2  
FIB Probe = 30KV:50 pA  
FIB Milling Probe = 30KV:500 pA

ESB Grid = 296 V  
Stage at T = 54.0 °  
System Vacuum = 2.48e-006 Torr

Date :31 Jul 2008  
Tilt Corr. = On



# Focused Ion Beam - SIMS Depth Profiling

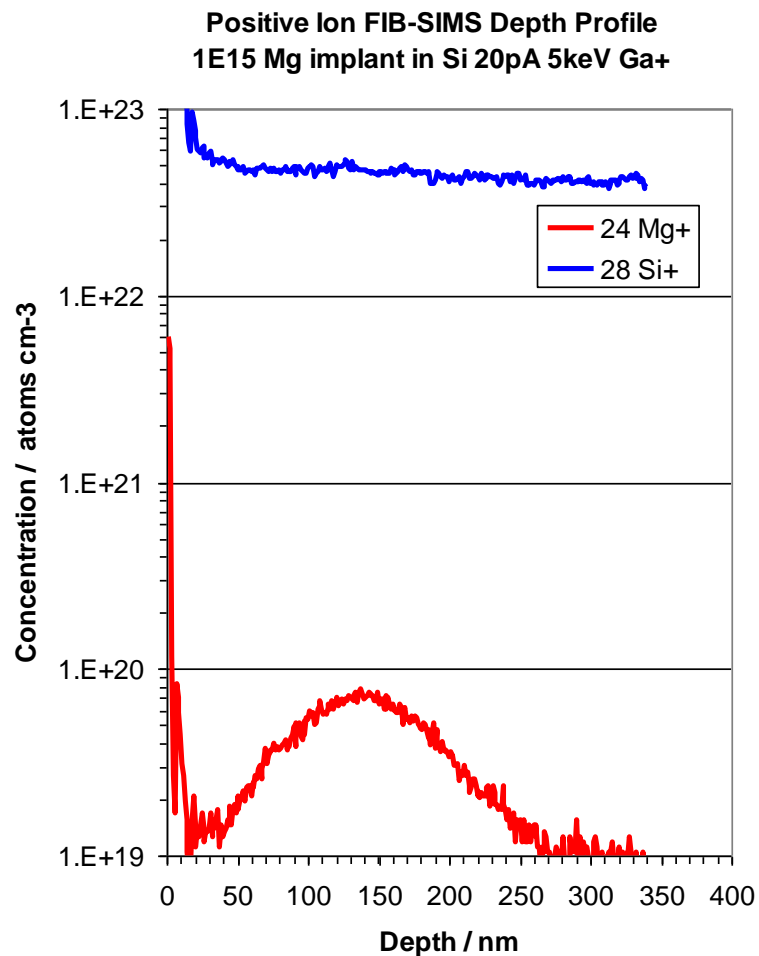

Peak of Mg implant is  $7 \times 10^{19}$  atoms cm<sup>-3</sup>  
~ 0.15% atomic

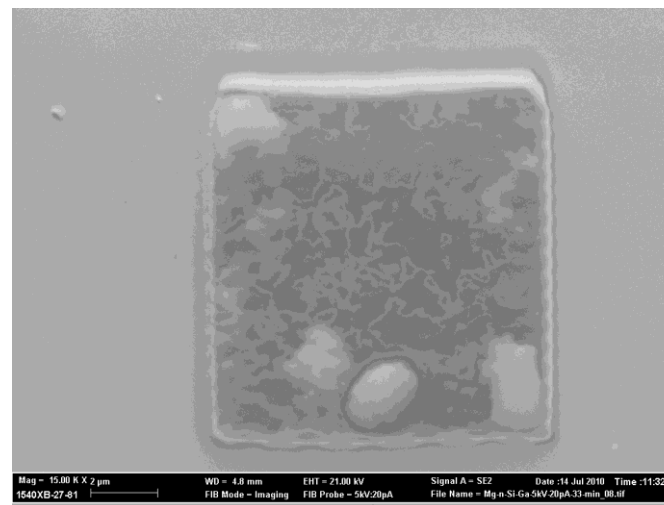

# Focused Ion Beam – SIMS Mass Spectrum

Analysis of individual zircon grains in a possible meteoritic rock sample  
- can FIB SIMS determine if it is actually likely to be extra terrestrial in origin?

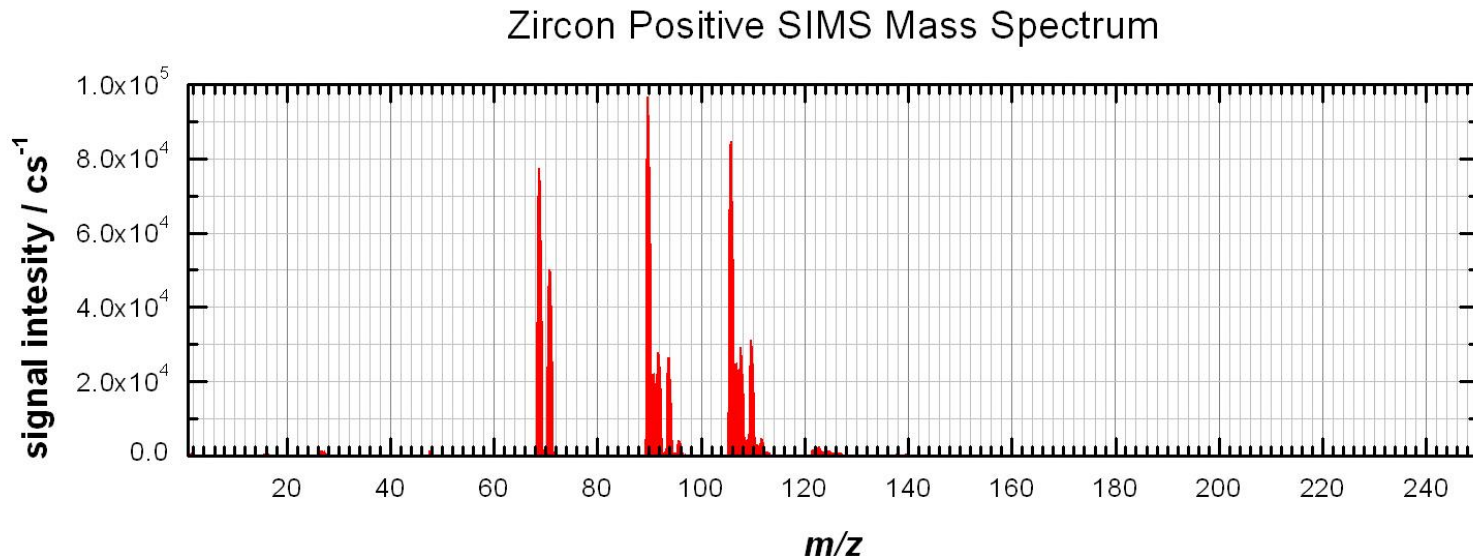

The spectrum above (plotted on a linear intensity scale) shows three significant groups. Ga from the ion probe is visible at  $m/z=69$  and  $71$  with Zr and ZrO isotopes appearing from  $90$  and  $106$  respectively. A small signal caused by ZrO<sub>2</sub> is also discernable from  $122$ .

# Focused Ion Beam – SIMS Mass Spectrum

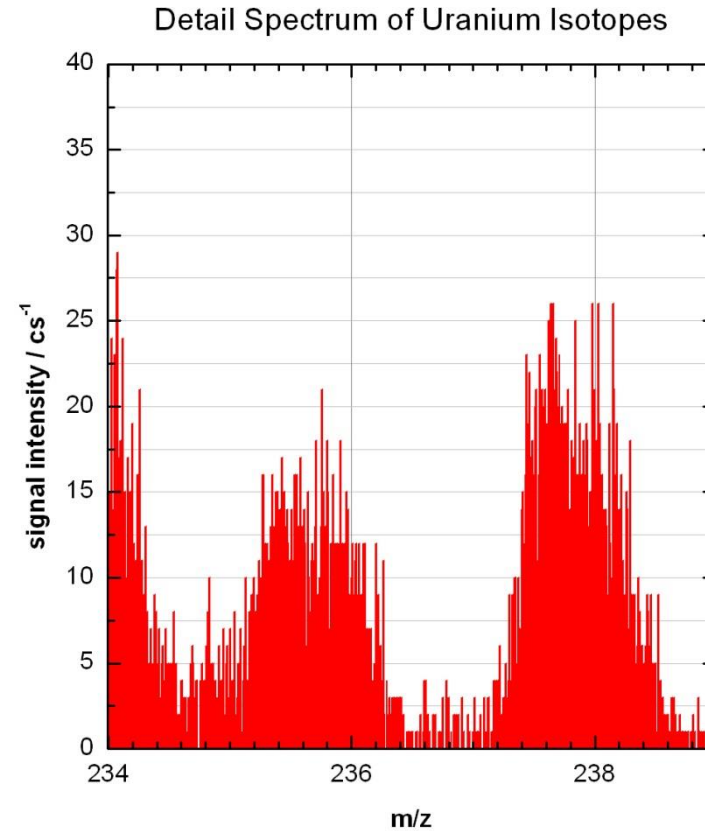
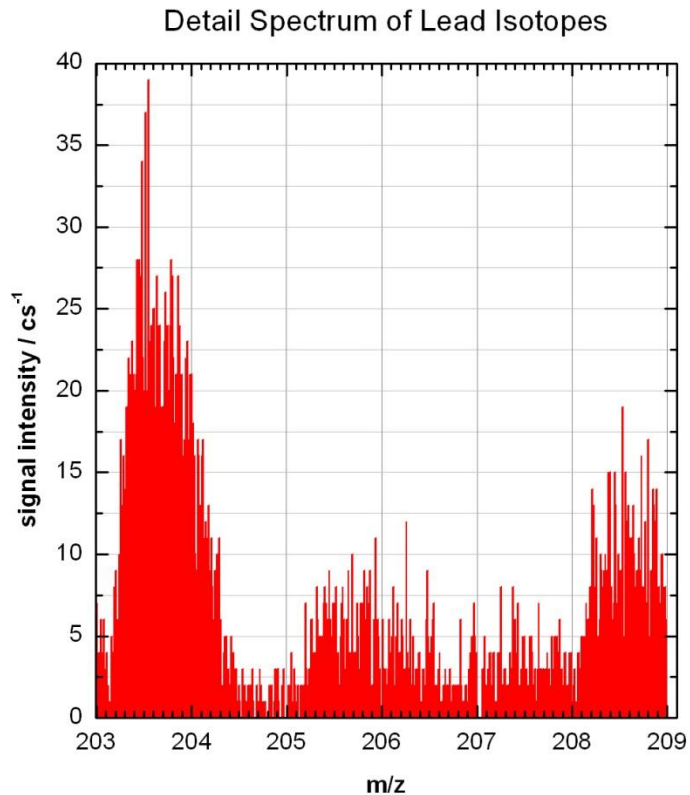

SIMS can be used to analyse the isotopic abundance of elements, in this case low levels of Pb and U in the Zircon sample



# Focused Ion Beam – SIMS Mass Spectrum

Integrating specific isotopes over time allows greater statistical significance.

206 Pb = 945 counts ( $\pm 3.3\%$ )  
207 Pb = 1141 counts ( $\pm 3\%$ )

**Ratio 206/207 =  $0.83 \pm 0.05$**

Primordial ratio – 0.9  
Present day crust ratio – 1.2

The sampled zircon is thus representative of the oldest material and therefore a good candidate for meteoritic origin.

Meteorite zircon isotope measurement

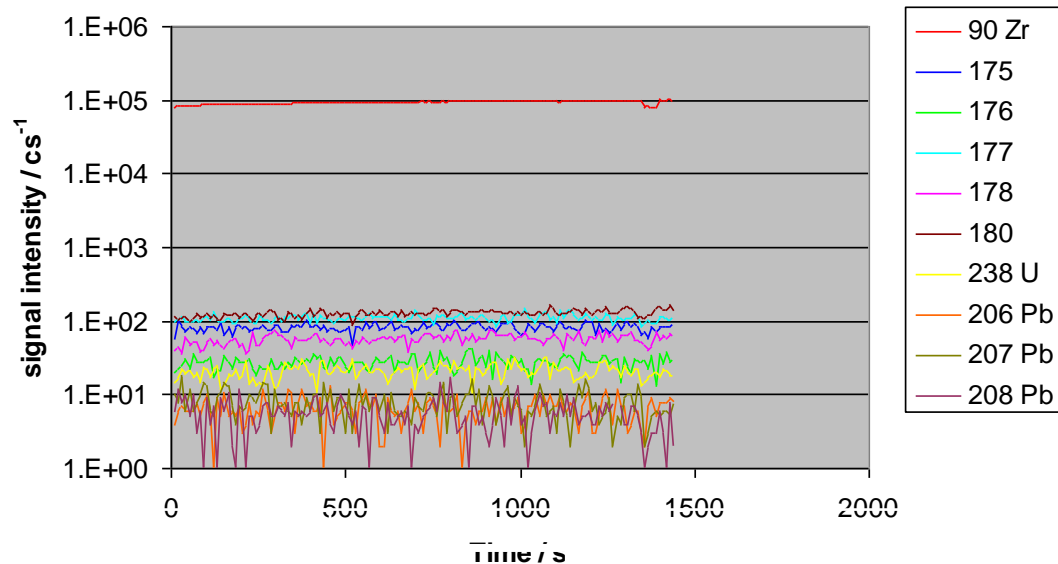

# New Hiden SIMS Software Suite

## Philosophy

- Collect all data as images in order to optimise the efficient use of sample material and time by allowing gating and inspection after collection.
- Aim to make it simple, reliable and safe for the inexperienced operator to obtain depth profiles whilst retaining the flexibility that enables expert user develop new protocols and have full control over every aspect of the instrument.



Control of the overall experiment and connection to the mass spectrometer

Periodic Table Species Selection

Periodic Table Species Selection

Available Isotopes	Exact Mass	Abundance
28Si	27.98	92.23
29Si	28.98	4.67
30Si	29.97	3.10

Atomic Mass	Chosen Species	Exact Mass	Abundance (%)
30	Si	29.97	3.10

Set Charge z = 1

Inference Calculator | Save to Custom List | Custom List Editor | Cancel | Done

Mass for analysis is chosen from a periodic table and can include molecules and multiply charged species. Experienced users can also input data directly.

**Interference Calculator**

The interference calculator generates a mathematically produced list from up to 5 elements to assist the user in species selection.

The appearance of a species in the list does not suggest that it will be actually observed.

- Unique, Single Charged Species
- Unique, Double Charged Species
- Interfered Single Charged Species
- Interfered, Double Charged Species

H  He  
 Li  Be  B  C  N  O  F  Ne  
 Na  Mg  Al  Si  P  S  Cl  Ar  
 K  Ca  Sc  Ti  V  Cr  Mn  Fe  Co  Ni  Cu  Zn  Ga  Ge  As  Se  Br  Kr  
 Rb  Sr  Y  Zr  Nb  Mo  Ru  Rh  Pd  Ag  Cd  In  Sn  Sb  Te  I  Xe  
 Cs  Ba  Hf  Ta  W  Re  Os  Ir  Pt  Au  Hg  Tl  Pb  Bi  
 La  Ce  Pr  Nd  Sm  Eu  Gd  Tb  Dy  Ho  Er  Tm  Yb  Lu  
 Th  U

Set Charge  $z =$

Start Mass  Stop Mass

Isotope	Exact Mass	Abundance
470Si	46.98	0.01
480Si	47.97	0.01
51000	50.99	0.00
575Si	56.96	4.31
585Si	57.95	2.86
595Si	58.95	0.14
6200Si	61.97	0.18
6300Si	62.98	0.00
7305Si	72.95	4.30
7405Si	73.96	0.00
75As	74.92	100.00
7505Si	74.94	0.14
7505Si	74.96	0.01
7605Si	75.95	0.00
7705Si	76.95	0.00
79000Si	78.97	0.00
875SiSi	86.93	0.13
910As	90.91	99.76
91005Si	90.95	0.01
920As	91.92	0.04
92005Si	91.96	0.00
930As	92.92	0.20

An integral interference calculator identifies possible mass interferences and suggests relative signal intensities

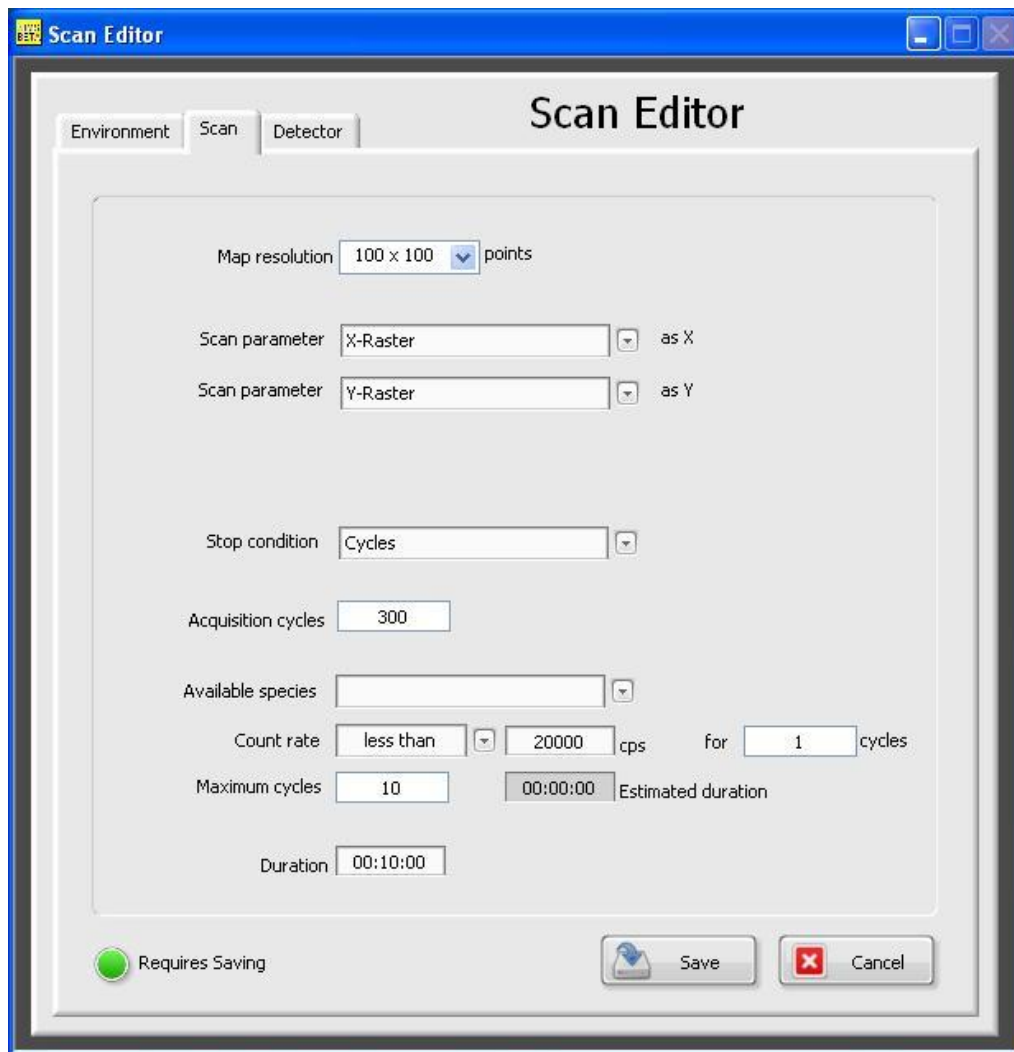

## Global Scan Editor

The image resolution is chosen and any stopping criteria set.

The depth profile can be set to terminate automatically when the set criteria is reached - such as an interface, time or signal level.

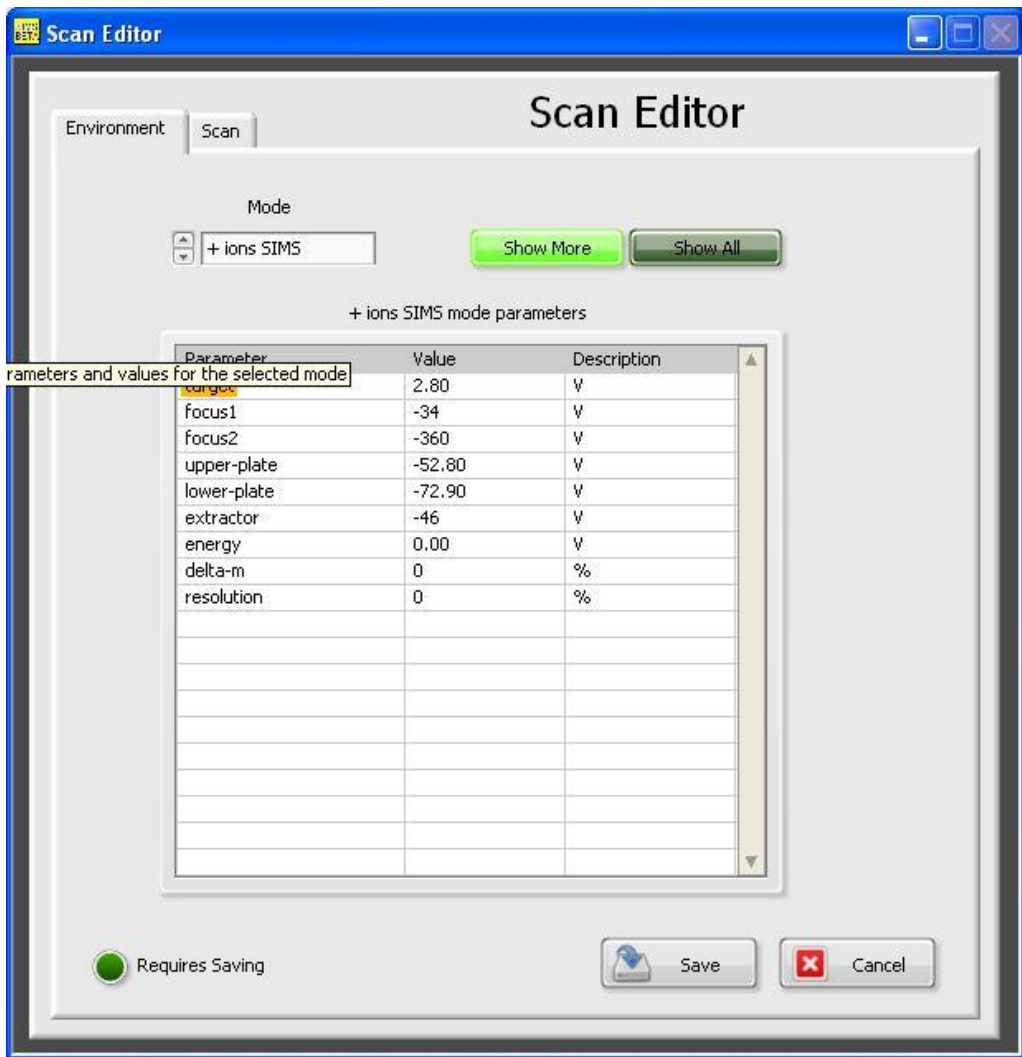

Parameters can be set for each mass, typically a target bias offset is used to differentiate molecular and atomic species.

The parameters list has three levels of access and complexity.



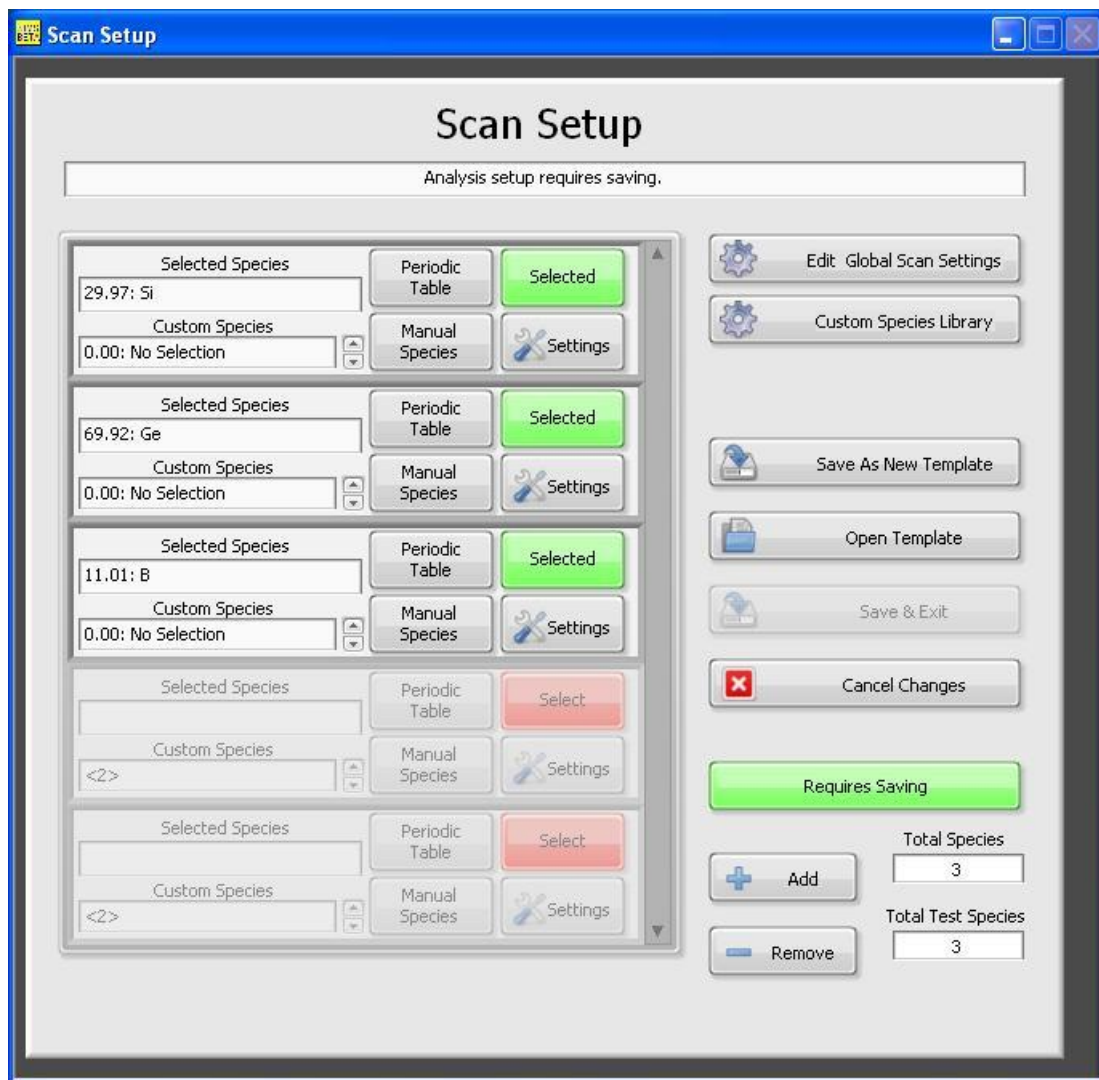

The experiment flow shown here has three channels (Si, Ge and B).

Species can be selected or deselected for analysis – this allows a non-expert user to control a range of experiments from a single template.

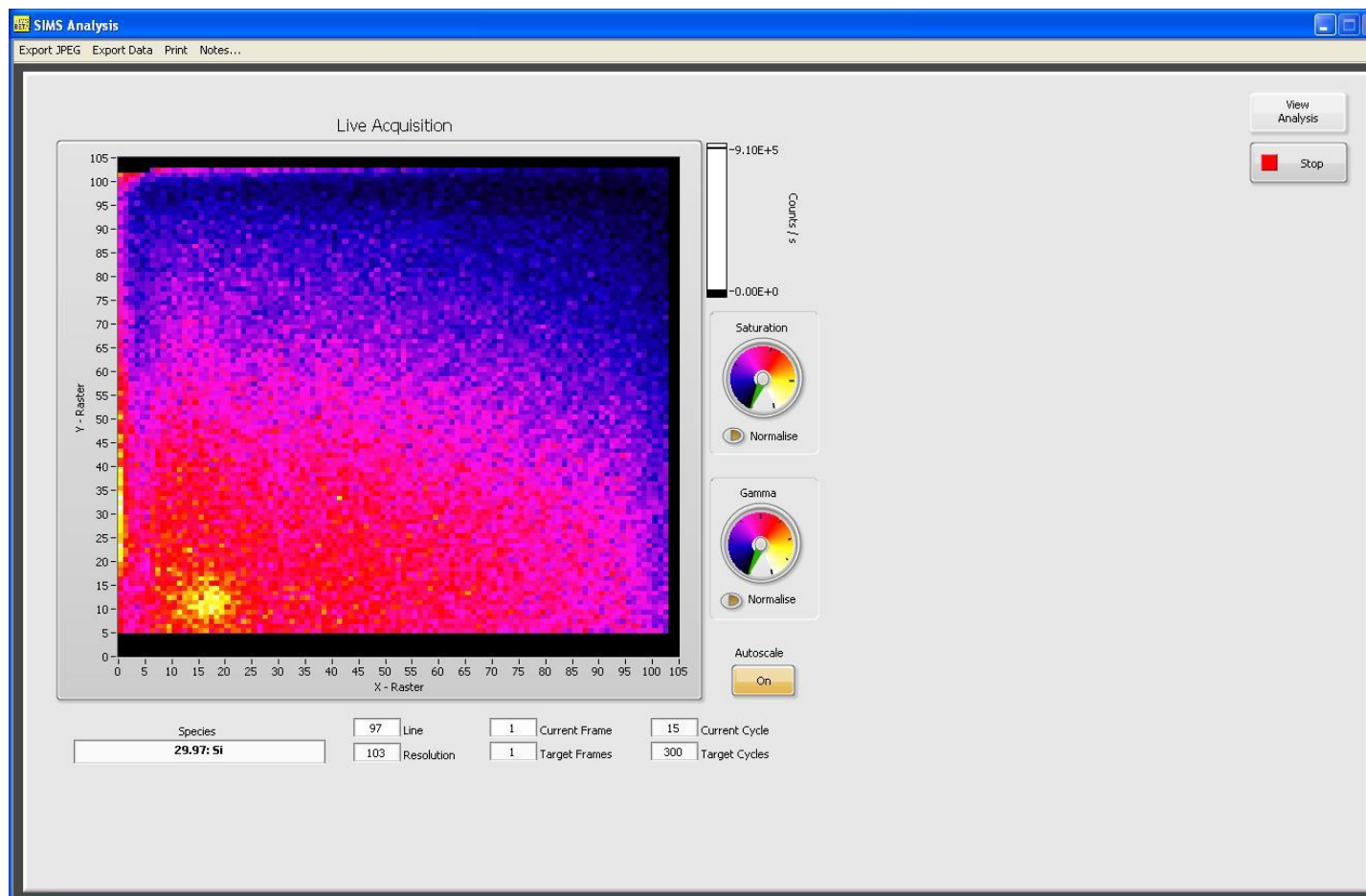

During analysis the live acquisition window displays the signal so that the progress of the experiment can be monitored and surface features observed.

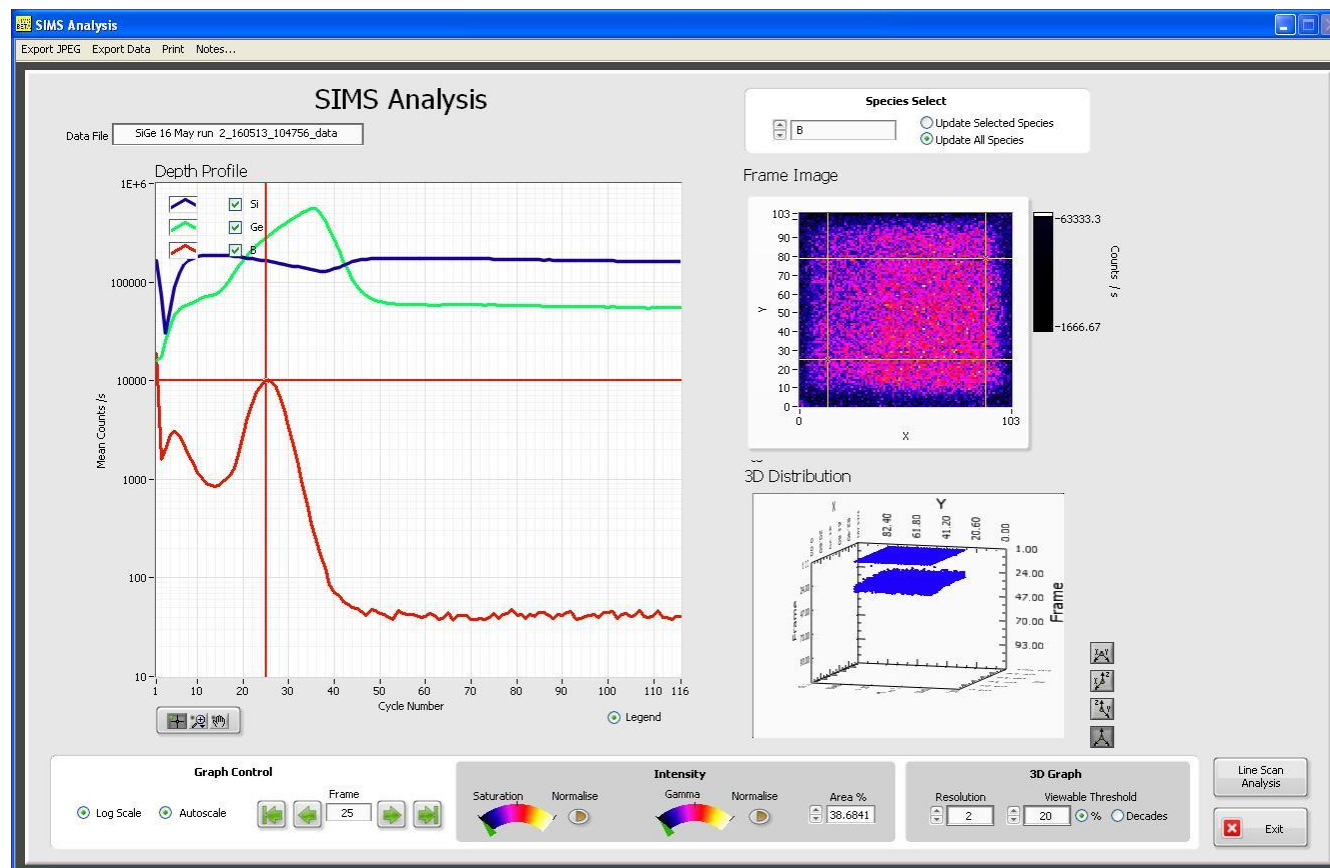

During analysis the analysis window displays the depth profile, image data and a 3D representation of the distribution. It also controls the electronic gating.

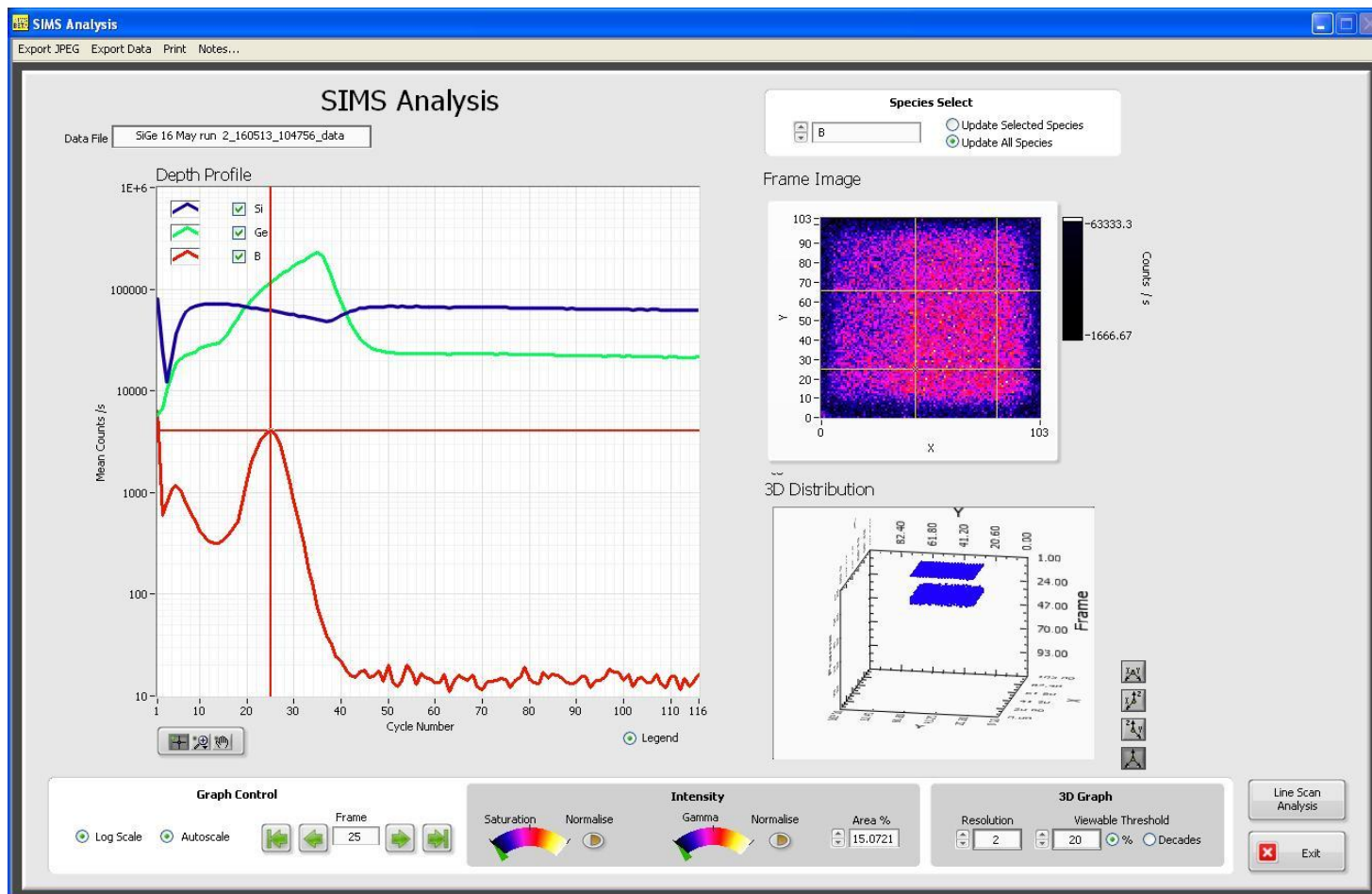

The electronic gate can be optimised independently and interactively for each mass and does not have to be concentric or square.

# 3D Profiling by SIMS

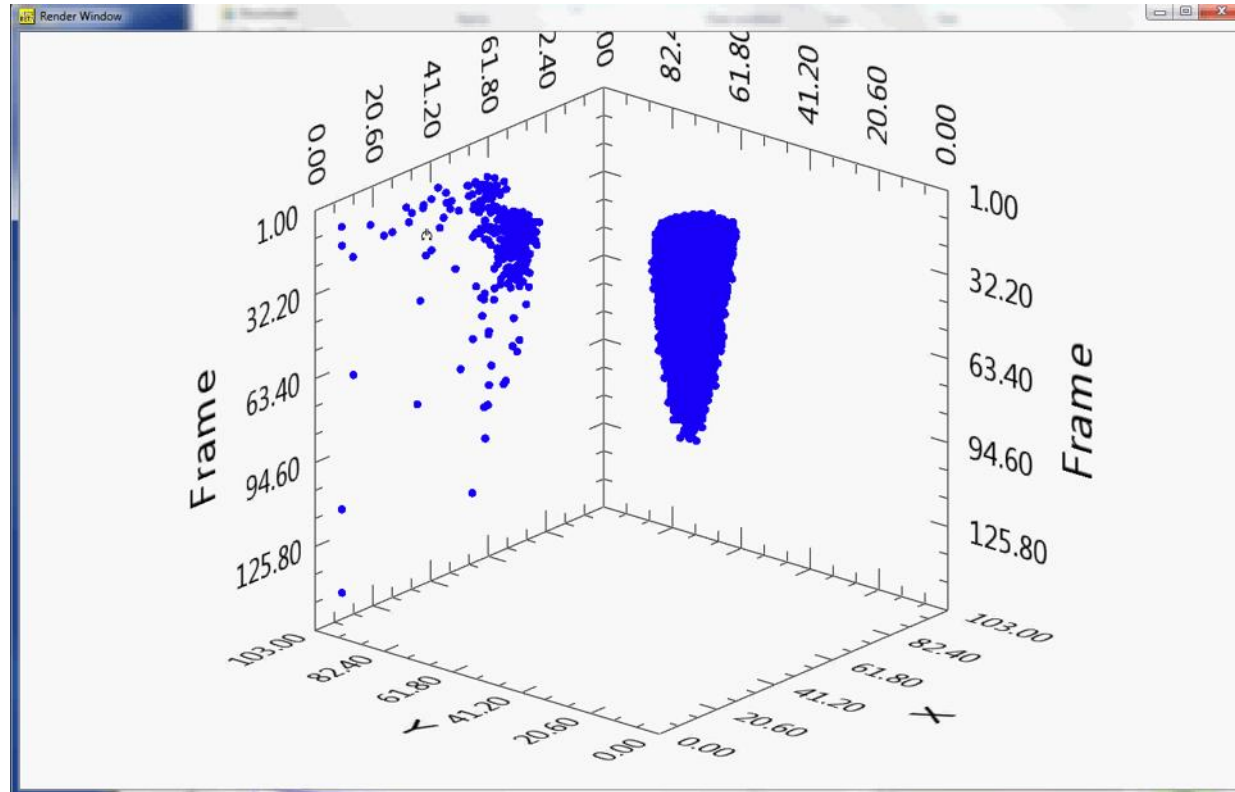

The video shows the mass resolved aluminium signal arising from aluminium oxide grit particles embedded in the work-piece after a grinding operation. Volume is 800 $\mu$ m square x 35  $\mu$ m deep.

# Case Study – Glass Coating (low-e glass)

Low emissivity glass is installed in buildings to increase energy efficiency. In cold weather it reflects heat back into the building – reducing heating costs; in hot weather it reflects heat from the external environment reducing heat build-up within and lessening required air conditioning capacity.

This is achieved, primarily, through the inclusion of a sputter deposited (typically 10nm thick) metallic silver layer within a sandwich of protective oxides.

Surrounding layers may be chosen to impart a particular colour to the glass but ideally white light should pass through so that colours are rendered correctly within the building.



# Case Study - Glass Coating (low-e glass)

## Low Emissivity Architectural Glass

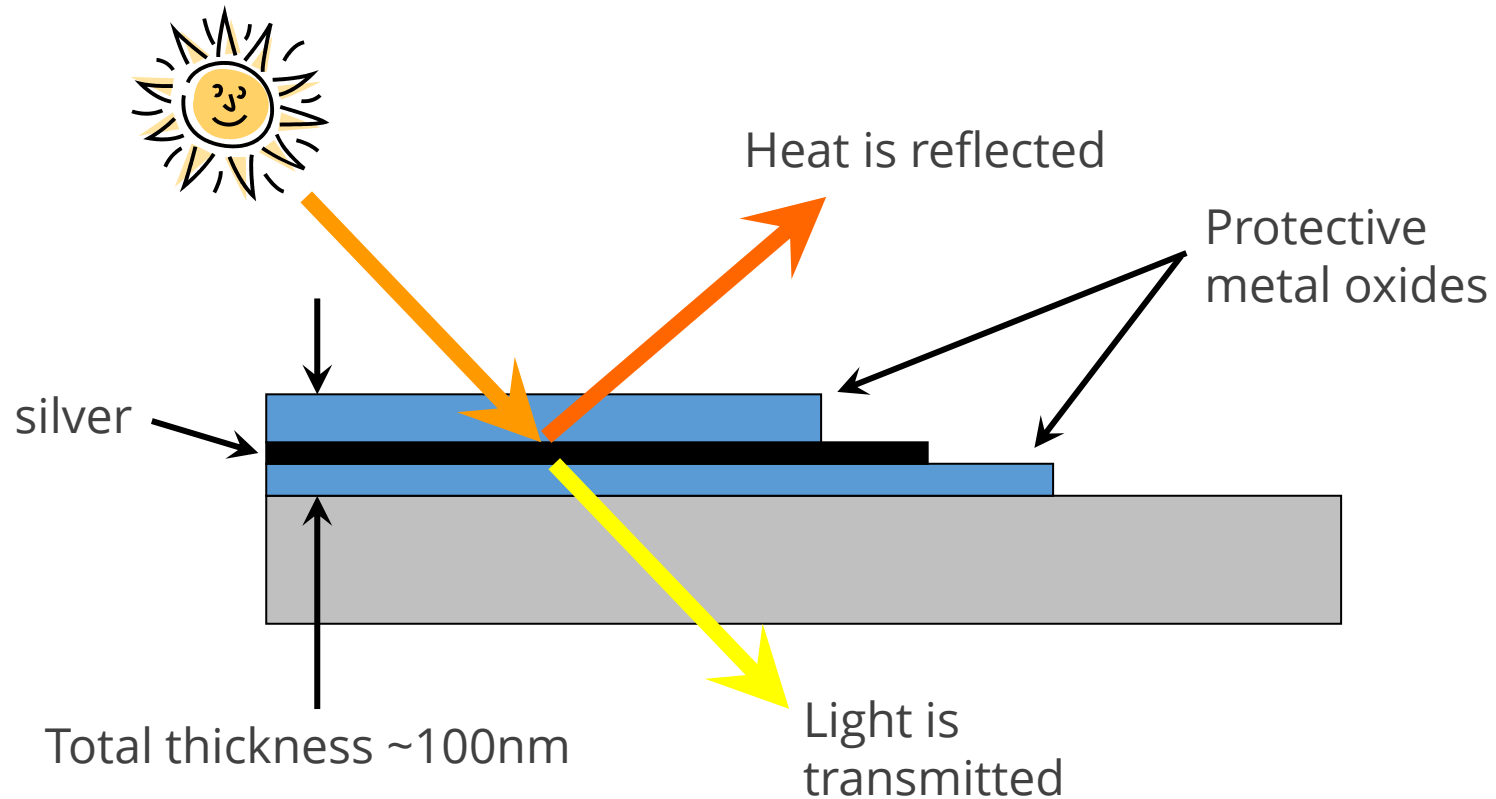



# Case Study – Glass Coating (low-e glass)

SIMS can provide analysis of glass layers for:

- Failure analysis, identification of defects, impurities and contamination
- Characterisation of processes
- Reverse engineering

# Case Study – Glass Coating (low-e glass)



The diagram shows a typical low-e stack where the active silver layer is protected by a mixture of metal oxide layers.

# Case Study - Glass Coating (low-e glass)

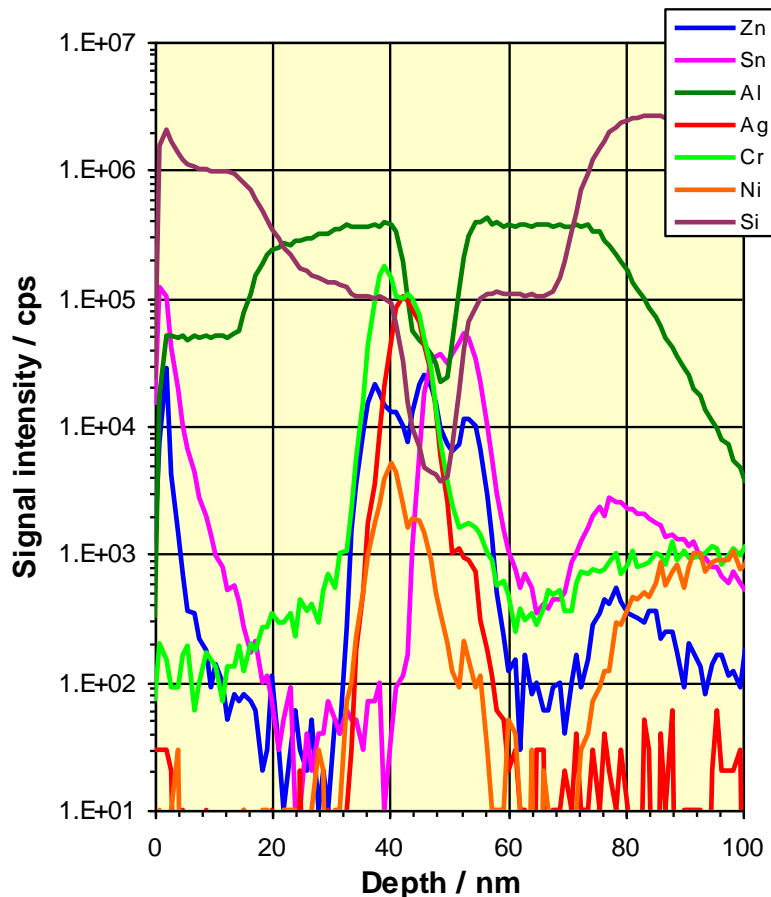

The SIMS depth profile was collected using 5keV Ar ions focused to an 80 $\mu$ m spot and rastered over an area of 400 x 550 $\mu$ m. Positive secondary ions were collected and a 500eV electron flood was employed to prevent surface charging.

# Case Study - Glass Coating (low-e glass)

Beginning at the exposed surface, the first layer is extremely thin and is partly consumed by the pre-equilibrium region at the start of the analysis. However, zinc and tin signals are clearly present at the very surface. There is a high silicon signal (rising to a level almost of that in the glass substrate) suggesting that a thin SiO<sub>2</sub> layer may exist in the vicinity of the ZnSnOx.

The silicon nitride layer is characterised by a uniform concentration of silicon, however, this layer also contains aluminium, estimated to be ~7% (atomic).

Beneath the SiN layer lies a similar thickness of AlN. Interestingly, throughout this layer the Cr signal is rising, albeit from three orders of magnitude below the eventual peak. SIMS is perfectly suited to the investigation of this type of low concentration feature and for the analysis presented here it was necessary to significantly reduce the sensitivity to ensure that the peak of the Cr signal did not saturate the detector.

The region below the AlN contains the thin silver layer and its associated thin protective barrier layers containing Zn, Al, Ni and Cr. The design thickness of the NiCrOx layer is only 1 nm and there has been some mixing of this into the silver layer during analysis.

Immediately below the silver, the thin Zn and ZnSnO layers are visible, before the final AlN layer and the glass substrate.

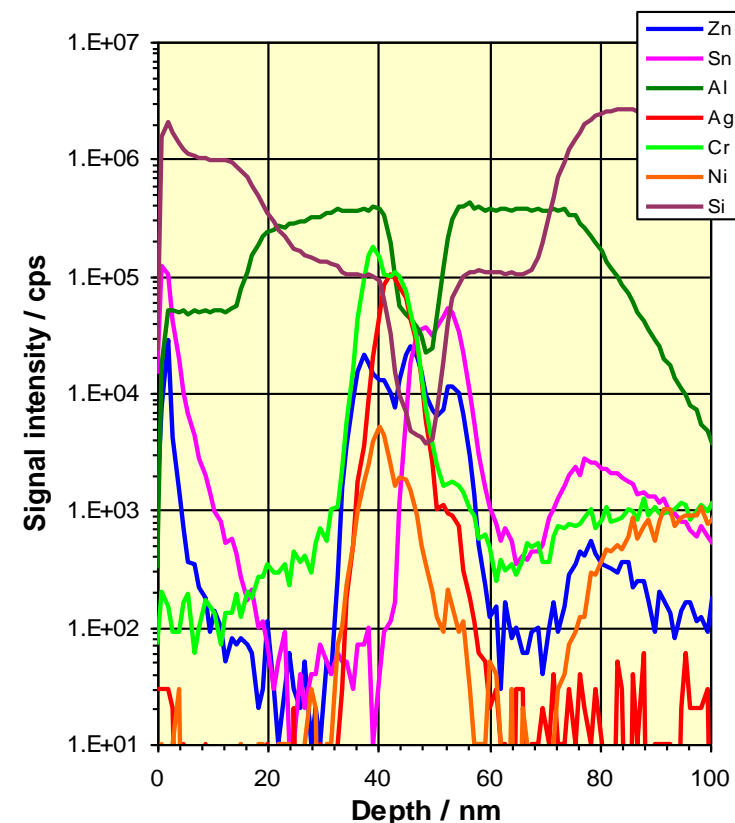

# Case Study – Glass Coating (low-e glass)

Such a profile is very complex to quantify, however, by comparing similar profiles from different parts of the glass pane it is possible to investigate abnormalities.

Here the silver and oxygen signals from left and right hand sides are overlaid, showing no difference.

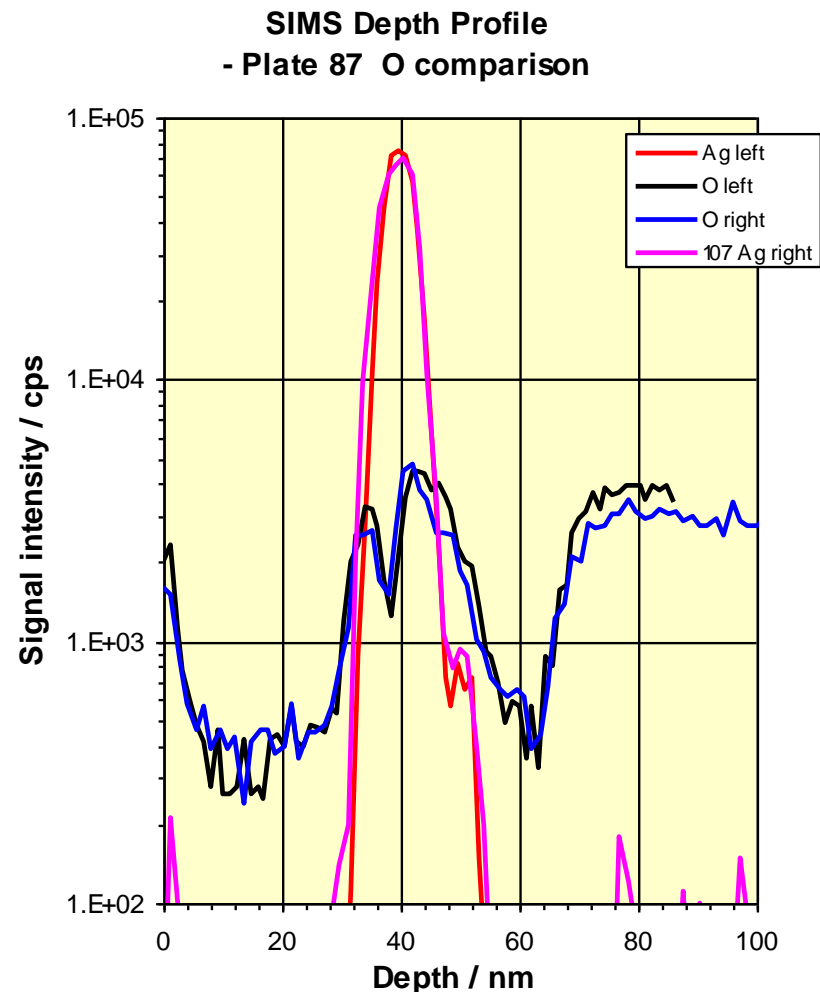



# Case Study - Glass Coating (low-e glass)

When the Cr signals from the left (L), middle (M) and right (R) hand sides are overlaid it becomes immediately apparent that the right hand edge is deficient in Cr.

It should be noted that the NiCr layer is expected to be only about 1 nm thick and so this represents a very sensitive analysis.

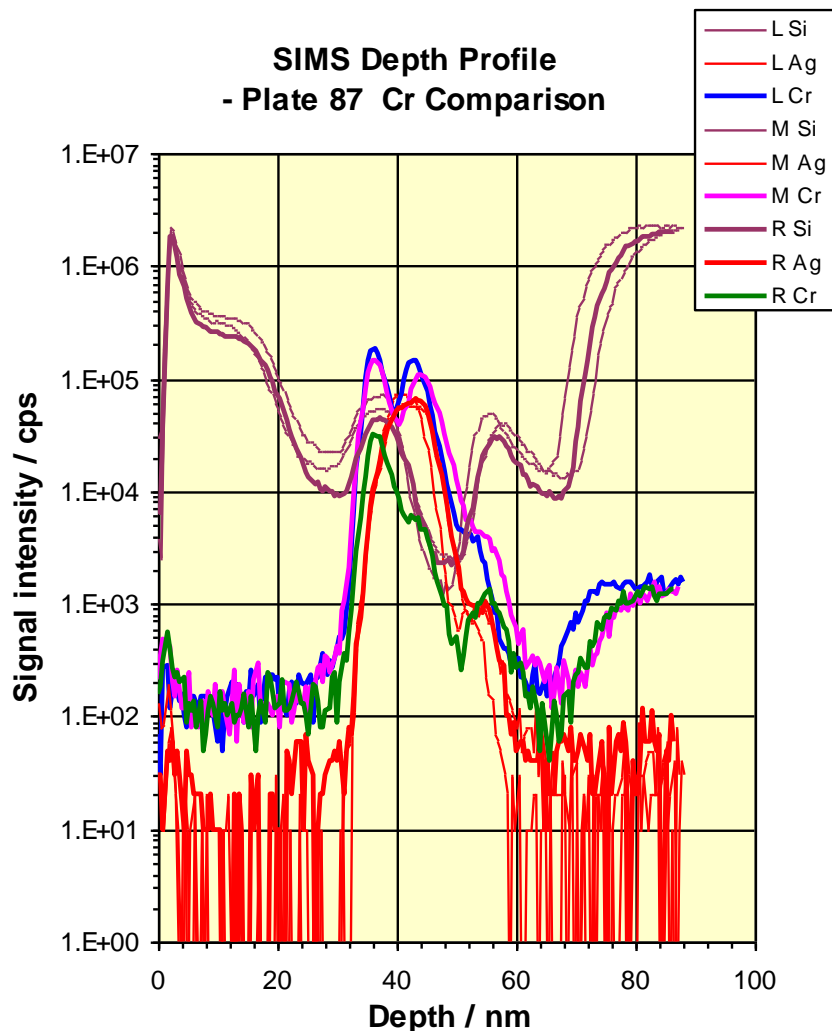

- 
- [www.HidenAnalytical.com](http://www.HidenAnalytical.com)
  - The Hiden website is an excellent resource with product pages, brochures, catalogues, product pages with some application notes, presentation and other information.
  - Contact +44 1925 445225 for direct support.